

**SL-1060 100W DSP controle [CO2-USB Laser Cutter lasersnijden Machine graveren](#) 1000 x 600 mm van ChinaCNCzone**

## **Uitstekende eigenschappen zoals hieronder**

Ares werkt: 600x1000mm

**Nieuwe DSP controller box niet nodig op de computer aansluiten.**

17HW4410H stap motor

Industriële niveau laser hoofd

Licht systeem: licht systeem

Kleur: bule en wit

Instelbare snelheid en kracht

USB-Interface

Air Assist, warmte en brandbare gassen uit het snijvlak verwijderen

De installatie van de ingesloten uitlaat ventilator, gemakkelijker, veiliger vervoer

Roterende as, een cilindrische object graveren

Cellulaire platform

Intuïtief bedieningspaneel, snelheid instellen, macht en meer controles rechtstreeks van de laser

Water koeling en beveiligingssysteem met een chiller.

Laser poneren

De onderkant van de noodstop.

Groter, 600 \* 1000mm werkvlak.

Hijs platform is elektrische bediening, 0-25 cm.

Laser brandpuntsafstand: 5CM

Een Hekschakelaar laat het kan alleen werken wanneer het deksel wordt gesloten.

**Er zijn Chinese, Engelse, Russische, Portugese, Italiaanse talen in het Configuratiescherm voor uw selectie**

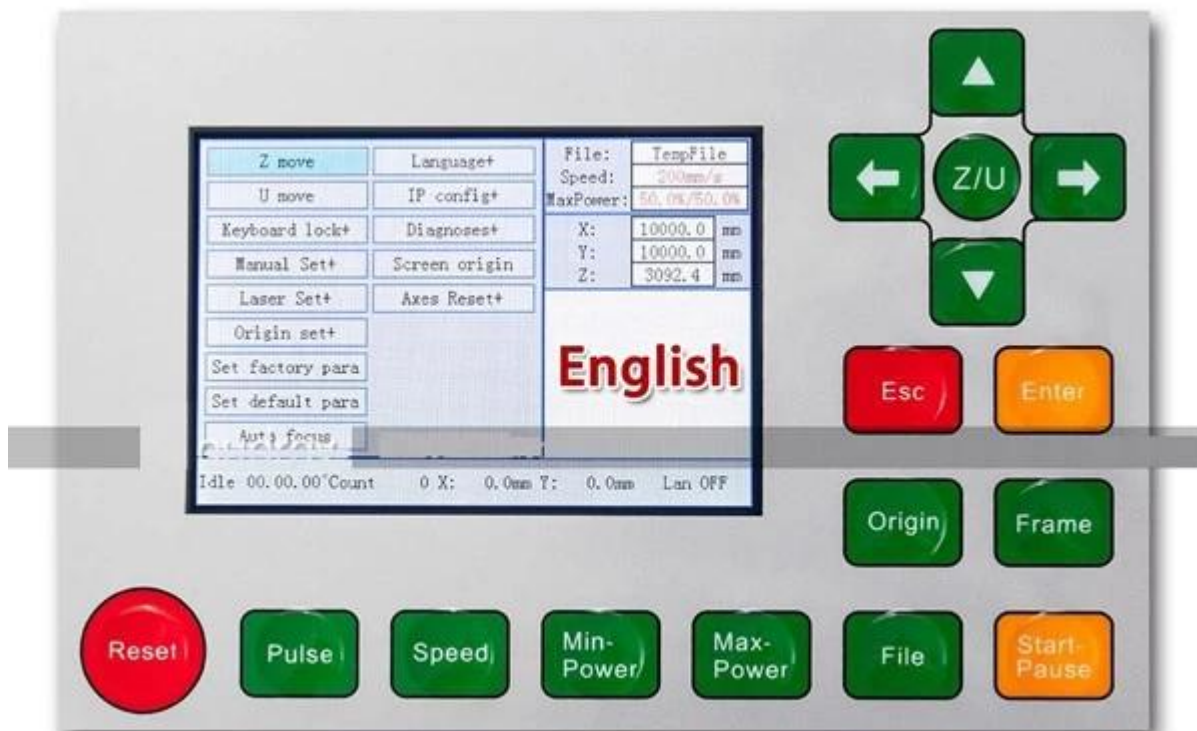

**Paklijst voor deze SL-1060 100W DSP Control CO2 USB Laser Cutter Laser Gravure snijmachine**

- 1 x DSP 1060 100W CO2 Laser Gravure machine
- 1 x Laser graveersoftware (naar beneden laden de verwijzing)
- 1 x gebruikershandleiding (naar beneden laden de verwijzing)
- 1 x CW-3000 industriële CHILLER

1 x uitlaat ventilator

1 x luchtpomp

1 x communicatie kabel en USB-kabel

1 x draaiingsas

1 x honingraat werkplatform

Twee pakketten:

1. machine pakket: houten kist met foam binnenkant

Pakket dimensie: 154 \* 112 \* 77CM

Bruto gewicht: 178 KG

Pakket gewicht: 267 KG

2. chiller pakket: kartonnen doos met schuim binnen

Pakket dimensie: 57 \* 48 \* 35CM

Bruto gewicht: 12 KG

Pakket gewicht: 20 KG



Parameters voor deze DSP-1060 [CO2 Laser Cutter](#)

Totaal vermogen	< 300W
Laser macht	100W
Laser type	<a href="#">CO2 laser gravure machine</a>
Voeding	AC 220V/110V
Werkgebied	600 * 1000 mm
Graveerdiepte	0-20 mm (ander materiaal afwijken)
Snijden diepte	0-20 mm
Gravure van snelheid	0-800mm/s
Snijnsnelheid	0-800mm/s
Hijs platform	0-250 honingraat mm werktafel
Lokaliseren van precisie	< 0,01 mm
Min vormgeving karakter	Karakter: 2 * 2mm, brief: 1 * 1mm

Bedrijfstemperatuur	5°C-45°C
Vochtigheid werken	5% - 95%
Resolutie verhouding	≤1000dpi
Data-overdracht-interface	USB 2.0 (offline)
Systeemomgeving	Windows XP / 7 Win / Win 8
Koeling	Water koeling en bescherming systeem met chiller
Grafische indeling die wordt ondersteund	De bestanden die CorelDraw & WinsealXP kunt identificeren (BMP, JPEG, PLT, CDR, AI) TIFF, PCX, DIB, TIF
Compatibele software	CorelDraw, WinsealXP
Kleurscheiding	NO
Hellende gravure	NO
Bescherming	Noodstop buttom en stoppen met werken wanneer water gebroken
Afmetingen van de machine	140 * 75 * 58 cm
Verpakking	Houten kist met foam binnenkant
Pakket dimensie	157 * 94 * 78 cm
Pakket gewicht	230 kg (Counted door volumetrisch gewicht)











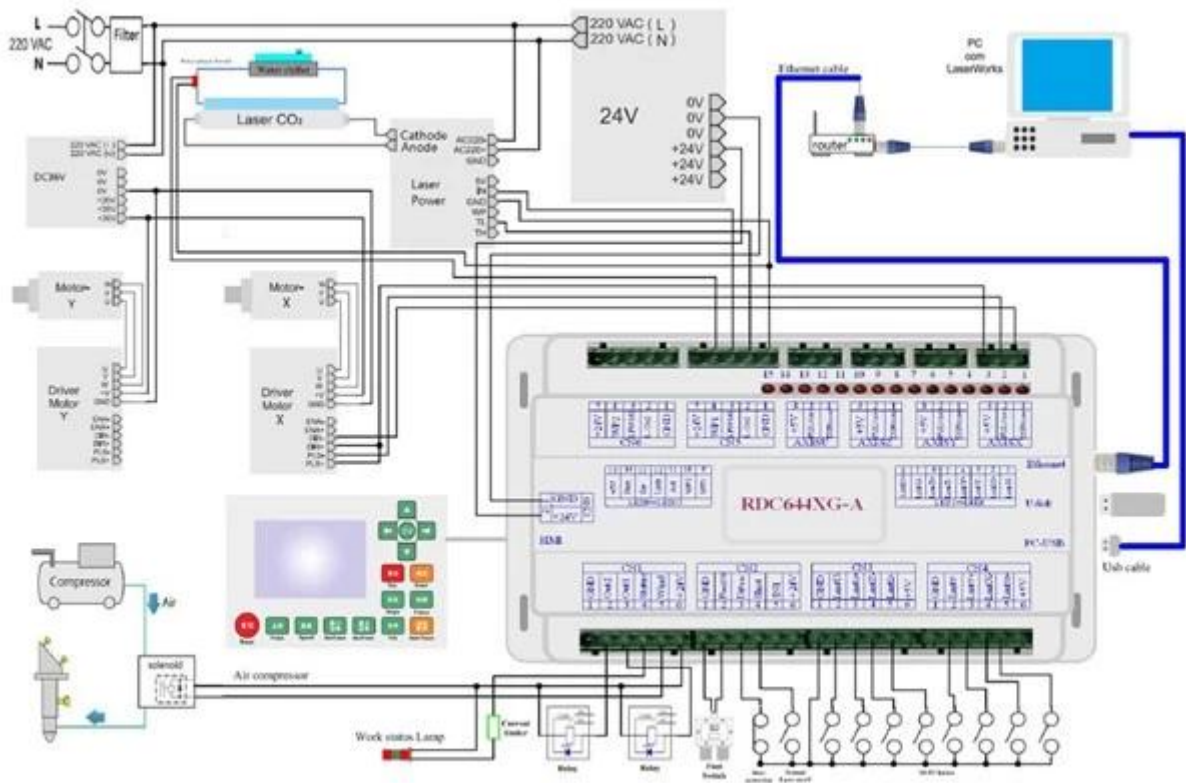
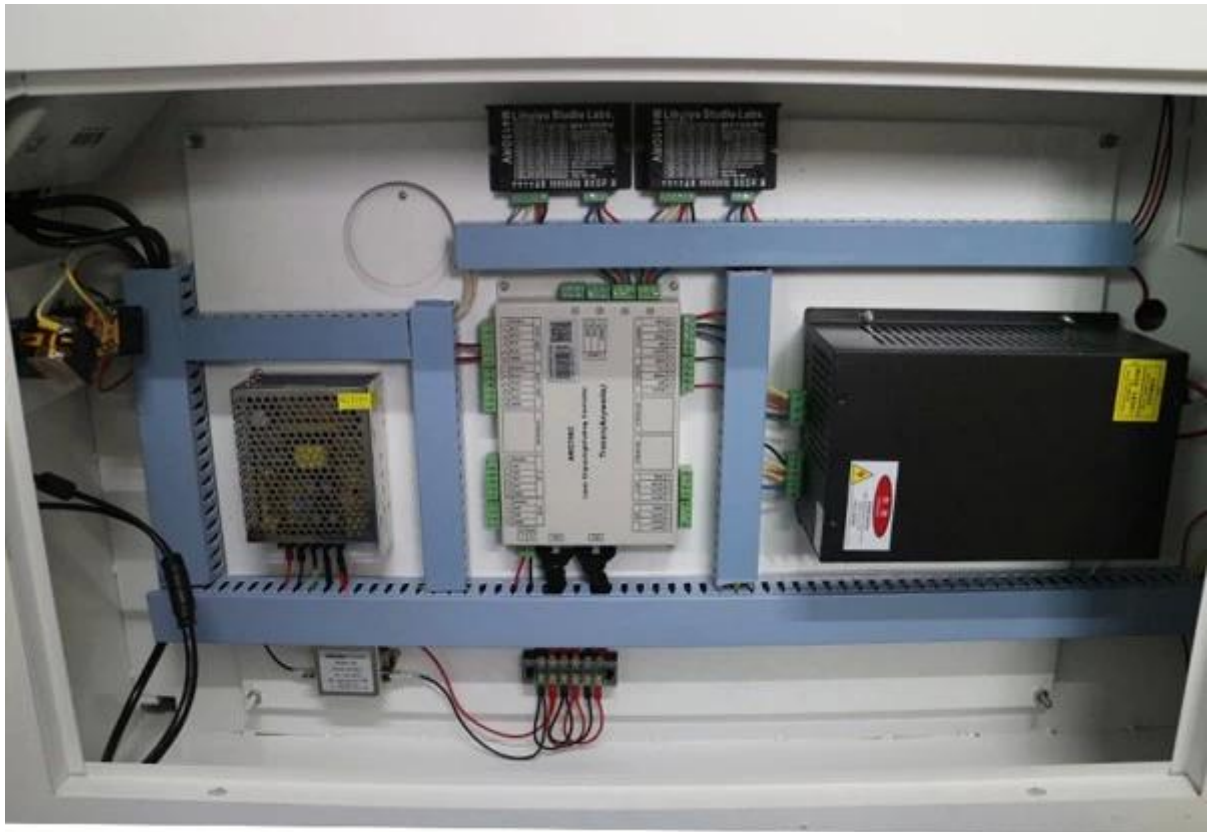

Red dot positionering functie (met overzichts- of laser dot-positie)

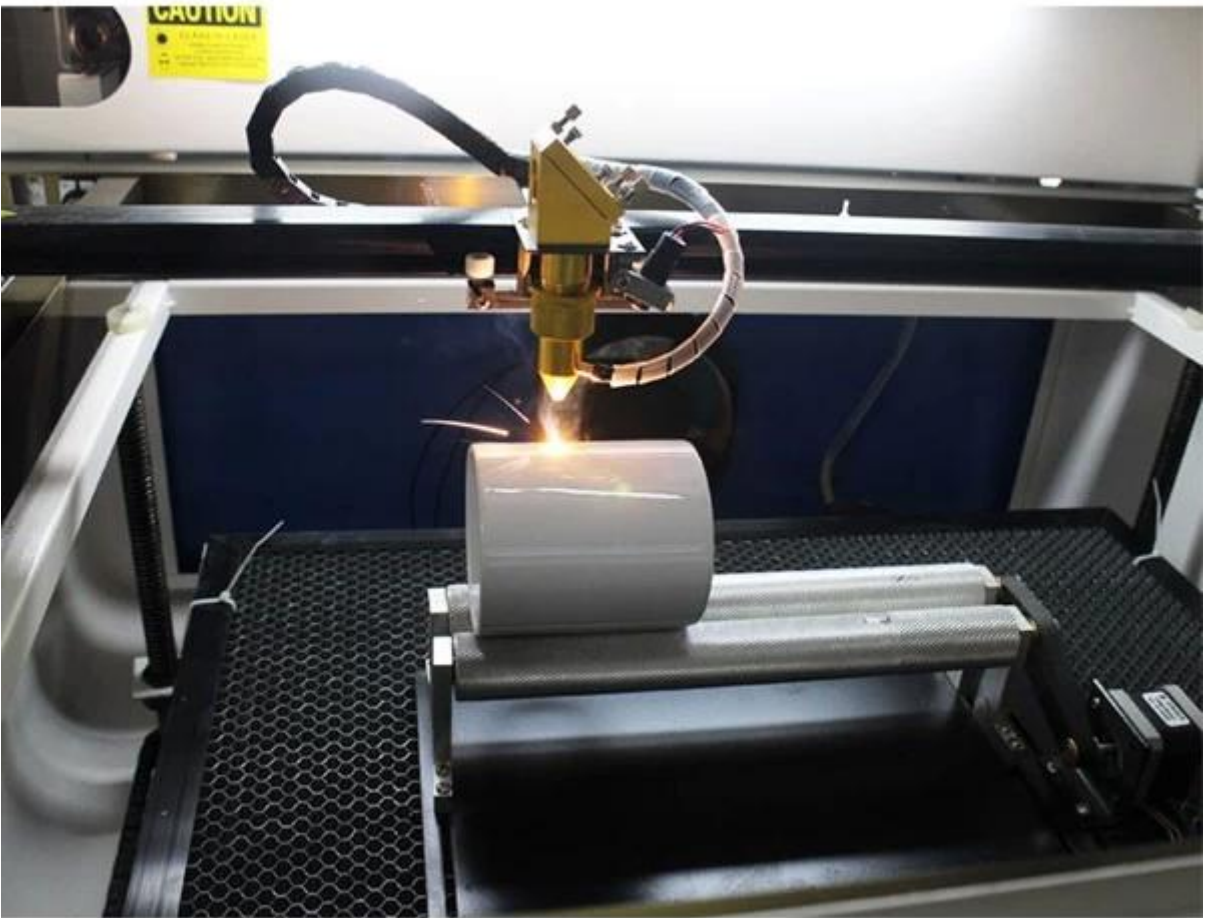
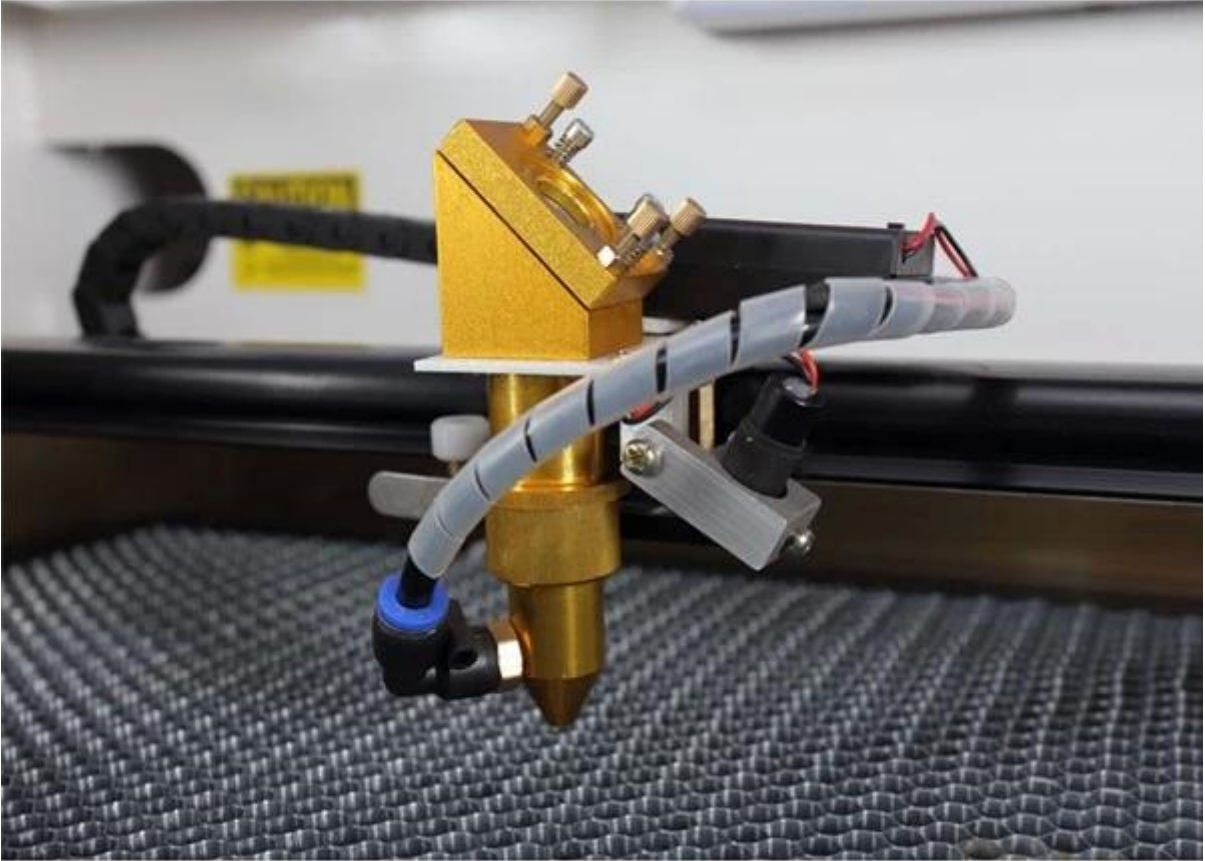

De CW-3000 industriële CHILLER

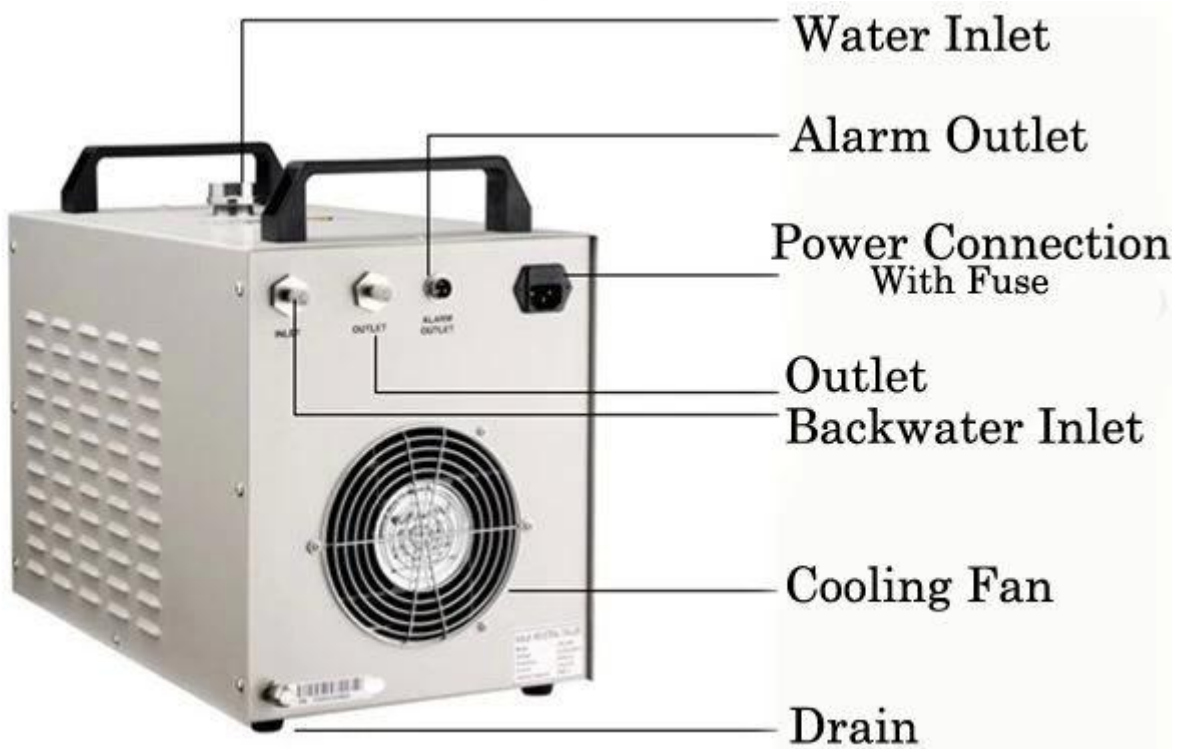

Honingraat (voor zachte materialen graveren en snijden)

## Honeycomb Work Bed Table Platform

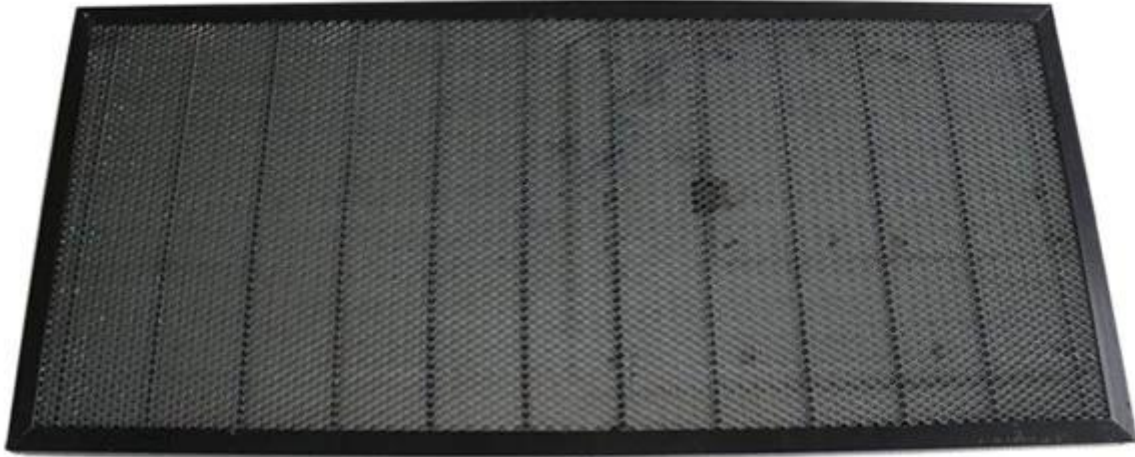

Luchtpomp voor dit SL-1060 100W DSP Control CO2 USB Laser Cutter lasersnijden Machine graveren



Hiervoor as voor deze SL-1060 100W DSP Control CO2 USB Laser Cutter Laser Gravure snijmachine

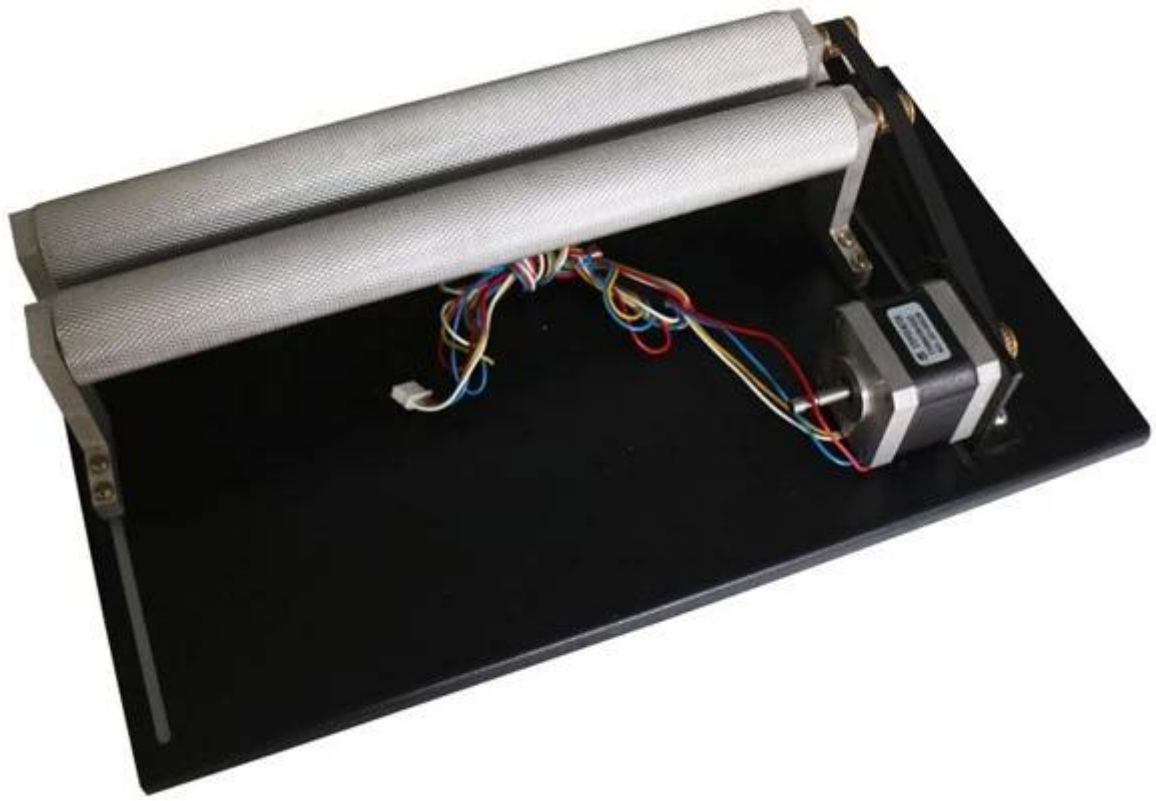

Deze SL-1060 100W DSP Control CO2 USB Laser Cutter Laser Gravure snijmachine is geschikt voor: houtbewerking, textiel snijden, industriële prototyping, industriële markering, Sign making, medische deel markering, lucht-en ruimtevaart, architecturale modellering, specialiteit reclame kunststoffen fabriceren, flexo, punt van aankoop, stempels, foto inlijsten, als cadeau, productie, bar codering, gravure, pakking snijden, puzzels, kasten, awards & erkenning, gepersonaliseerde pennen, deur trekt, gesneden scroll patronen, spellen & speelgoed, vinger gewrichten, inlays & overlays, broederschap peddels, speeldozen, lichtschakelaar platen, Jewelry Boxes jewelry boxes, delen markering, router sjablonen, Bureau.

Material	Engrave	Cut
Wood	Yes	Yes
Jade	Yes	
Acrylic	Yes	Yes
Glass	Yes	
Ceramic	Yes	
Delrin	Yes	Yes
Cloth	Yes	Yes
Leather	Yes	Yes
Marble	Yes	
Matte Board	Yes	Yes
Melamine	Yes	Yes
Paper	Yes	Yes
Mylar	Yes	Yes
Press Board	Yes	Yes
Rubber	Yes	Yes
Wood Veneer	Yes	Yes
Fiberglass	Yes	Yes
Painted Metals	Yes	
Tile	Yes	
Plastic	Yes	Yes
Cork	Yes	Yes
Corian	Yes	Yes
Anodized Aluminum	Yes	
Ceramics	Yes	
Stainless Steel	*	
Brass	*	



**"" means you have to use a spray called "thermark" to spray the surface of the material and then you can mark on it.**



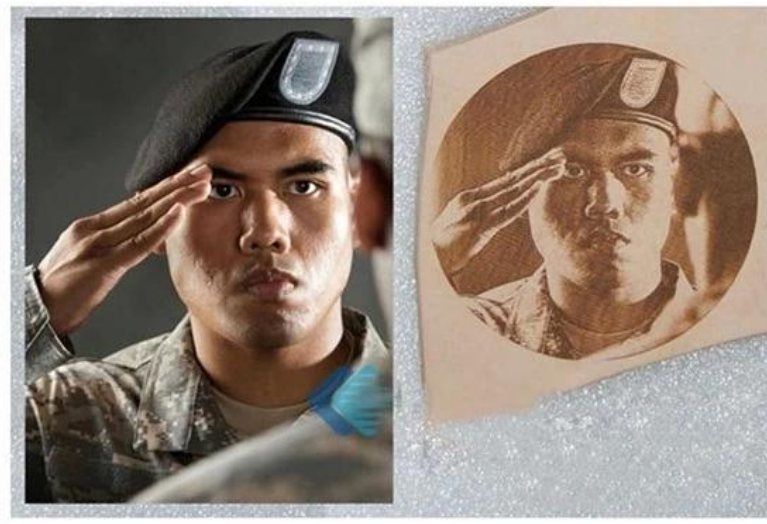
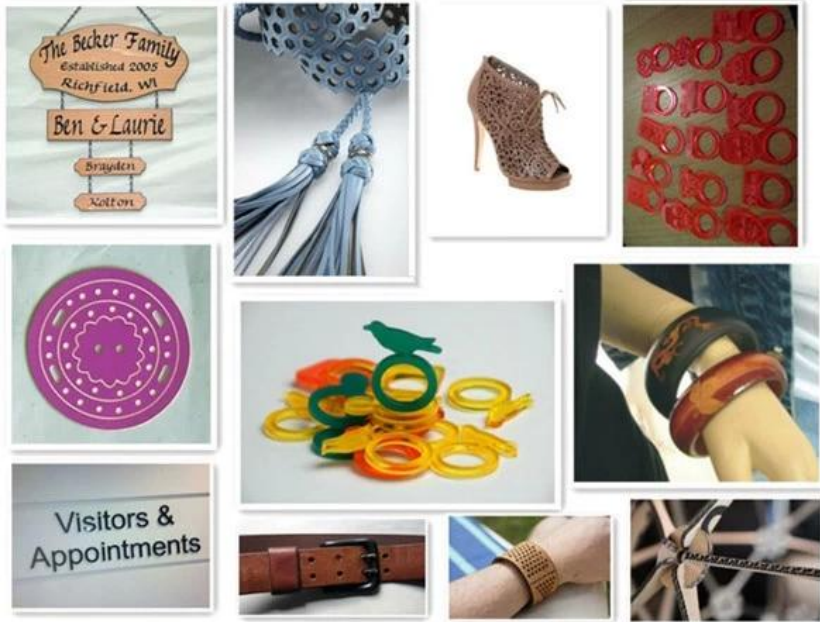



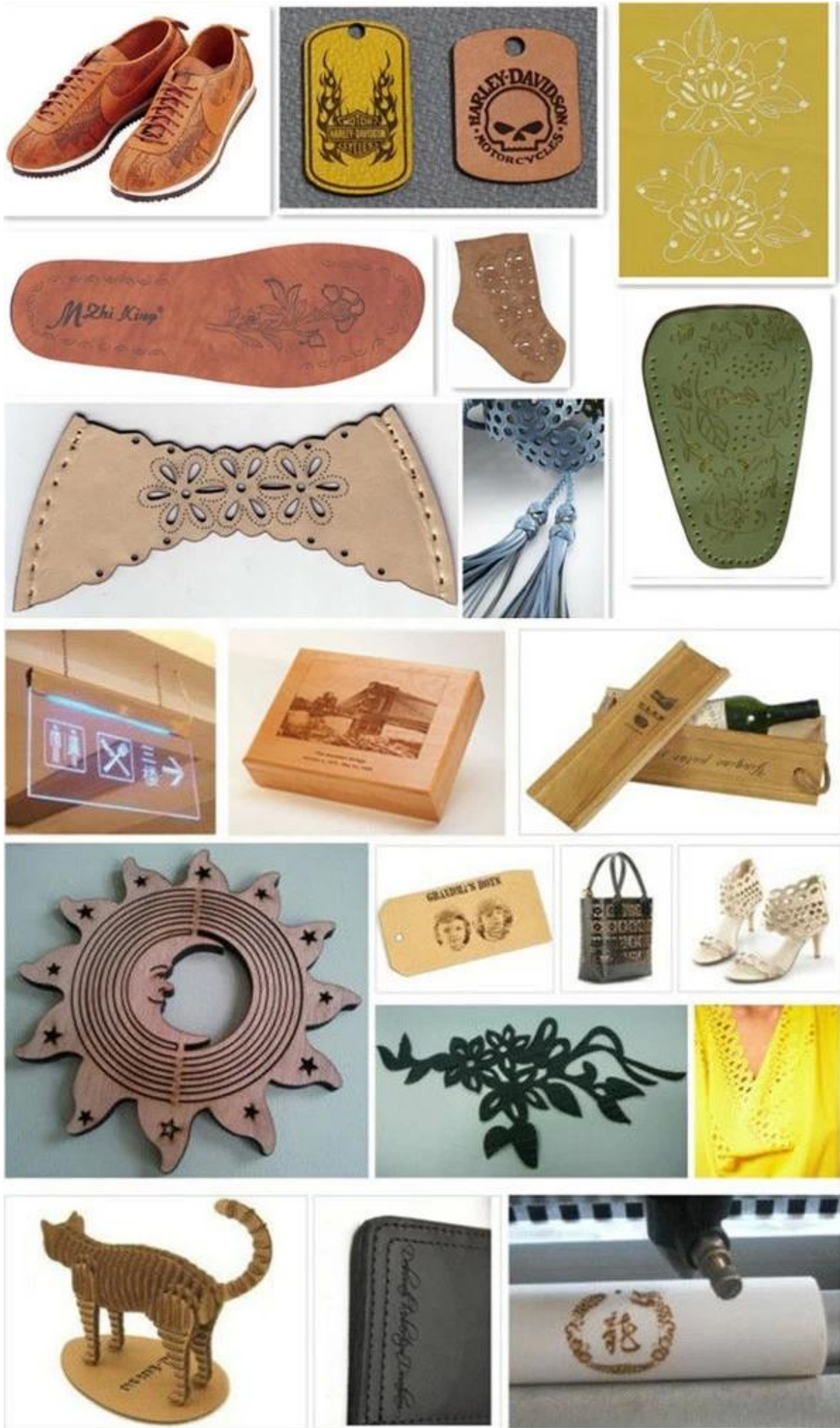

Material	Type	Thickness	Speed
Acrylic	Engrave		
	Cut	15-20MM	2mm/s
Soft wood	Engrave		
	Cut	10MM	6mm/s
Leather	Engrave		
	Cut		30mm/s
Plastic	Engrave		
	Cut		Depending on the material
Glass	Engrave	0.1-0.2MM	
	Cut	Can't	Can't
Plexiglass	Engrave		
	Cut	Effect is not as good as acrylic	Speed slower than the acrylic
PVC	Engrave		
	Cut	Same with acrylic	Same with acrylic
Cloth	Engrave		
	Cut	Usually thin material	50mm/s
Rubber	Engrave		
	Cut	5mm	10mm/s
Bamboo	Engrave		
	Cut	10mm	4mm/s

## 05 Factory Tour

China  zone





06 **Certifications**

**China  zone**





Vriendelijke opmerking: U kan kochten onder artikel:  
[Hoe het Water Chiller & luchtpomp verbinden met ChinaCNCzone Desktop CO2 Laser Gravure Machine?](#)