

sl-1060 100w dsp [usb](#) 1000 x 600 mm

ares: 600 x 1000mm

ares: 600 x 1000mm

dsp

17 h 44 10h

bule

usb

600 * 1000mm

0-25cm

5cm

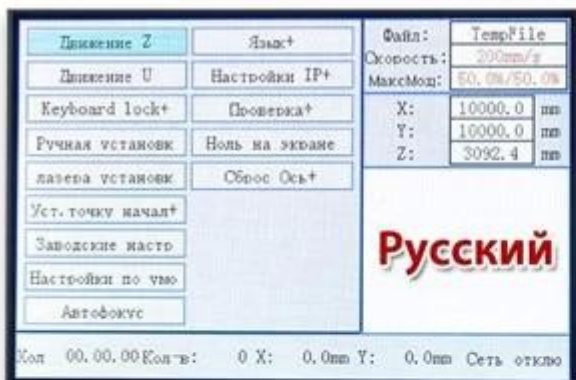
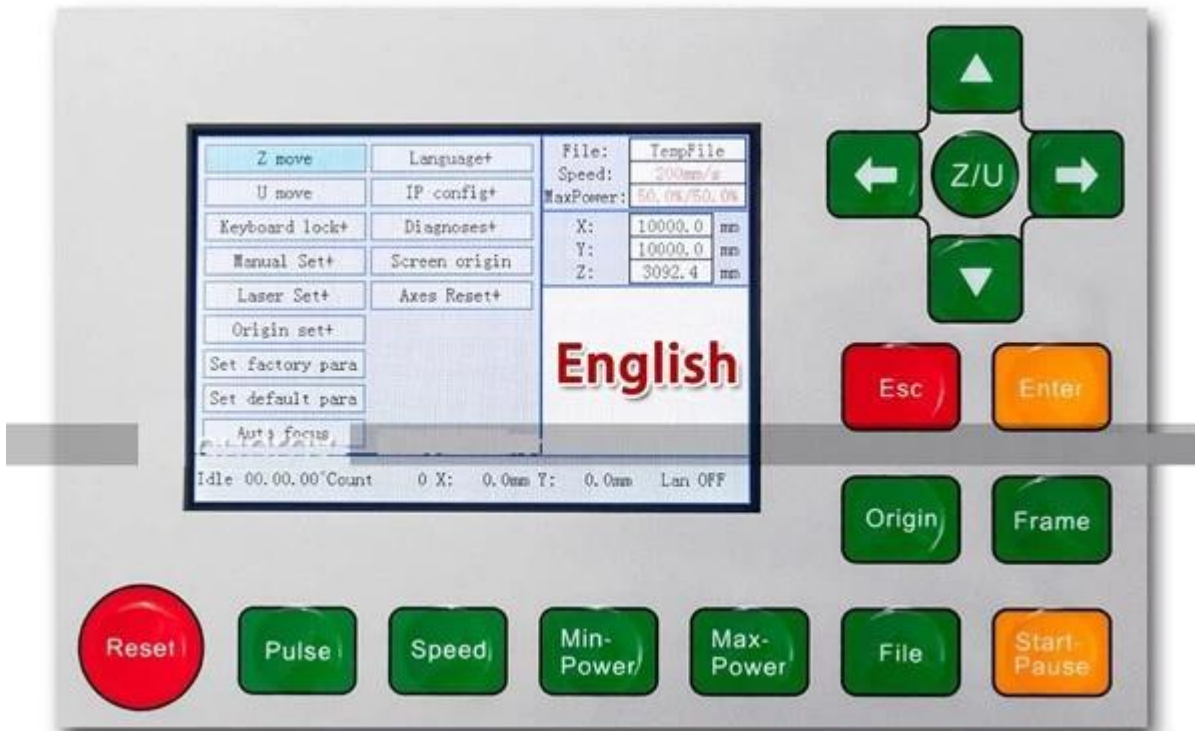

1 x SI 1060 100w dsp co2 usb

1 x dsp 1060 100w c 02

1 x ()

1 x ()

1 x cw-3000

1 x

1 个 x 个 个

1 个 x 个 个 个 usb 个

1 x 个 个

1 个 x 个 个 个 个 个

2 个 个:

1. 个 个: 个 个 个 个 个

个 个: 154 * 112 * 77 cm

个 个: 172 kg

个 个: 260 kg

2. 个 个 个: 个 个 个 个 个

个 个: 57 * 48 * 35cm

个 个: 12kg

个 个: 20kg

02 Parameters China  zone

个 dsp 1060 个 个 个 [co2 个 个 个](#)

个 个 < 300w

个 个 个 100w

个 个 个 [个 个 个 个 个](#)

个 个 个 ac 220v/110v

个 个 600 * 1000 mm

个 个 0-20 mm (个 个 个)

个 个 0-20 mm

个 个 0-800mm/s

个 个 0-800mm/s

个 个 个 0-250 mm 个 个 个 个

个 个 个 < 0.01 mm

个 个 个 个 个 个 个: 2 * 2mm, 个 个: 1 * 1mm

个 个 5 °C-45 °C

显示比例	5%-95%
打印分辨率	≤ 1000 dpi
接口	usb 2.0 (前置)
操作系统	Windows xp/Windows 7/Windows 8
软件	CorelDRAW 软件、Photoshop 软件、Illustrator 软件
支持的格式	coreldraw & Windows xp 支持的格式 (bmp, jpeg, plt, cdr, ai,) tiff, pcx, dib, tif
支持的格式	coreldraw, Windows xp
重量	230 kg
尺寸	140 * 75 * 58 cm
包装尺寸	157 * 94 * 78 cm
重量	230 kg (含包装)









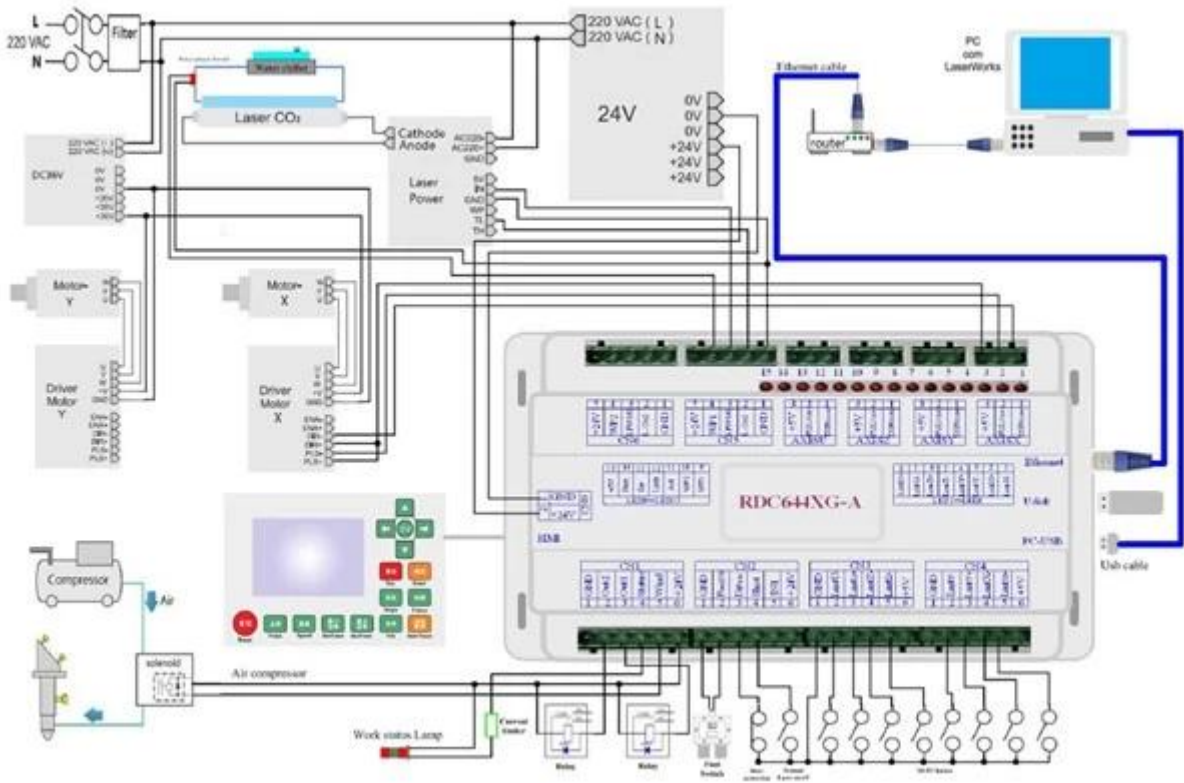
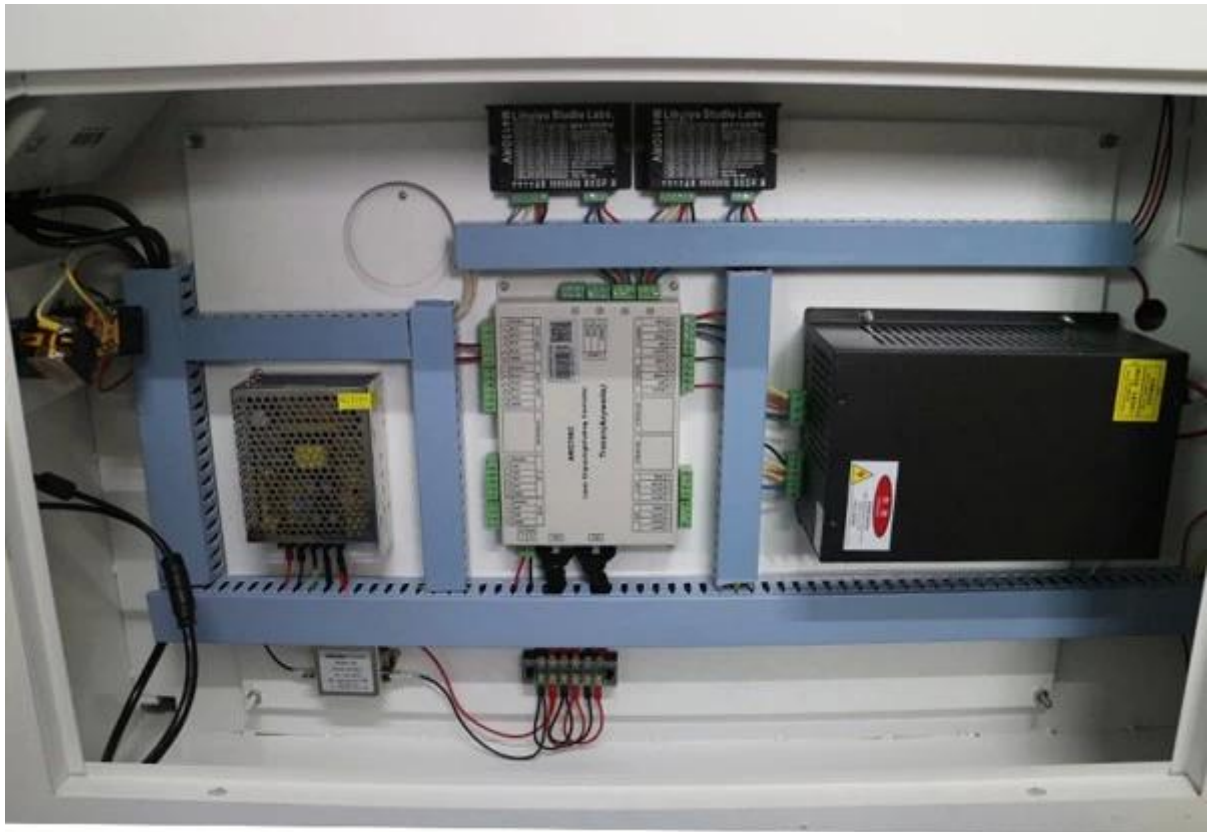

□ □ □ □ □ (□ □ □ □ □ □ □ □ □ □)

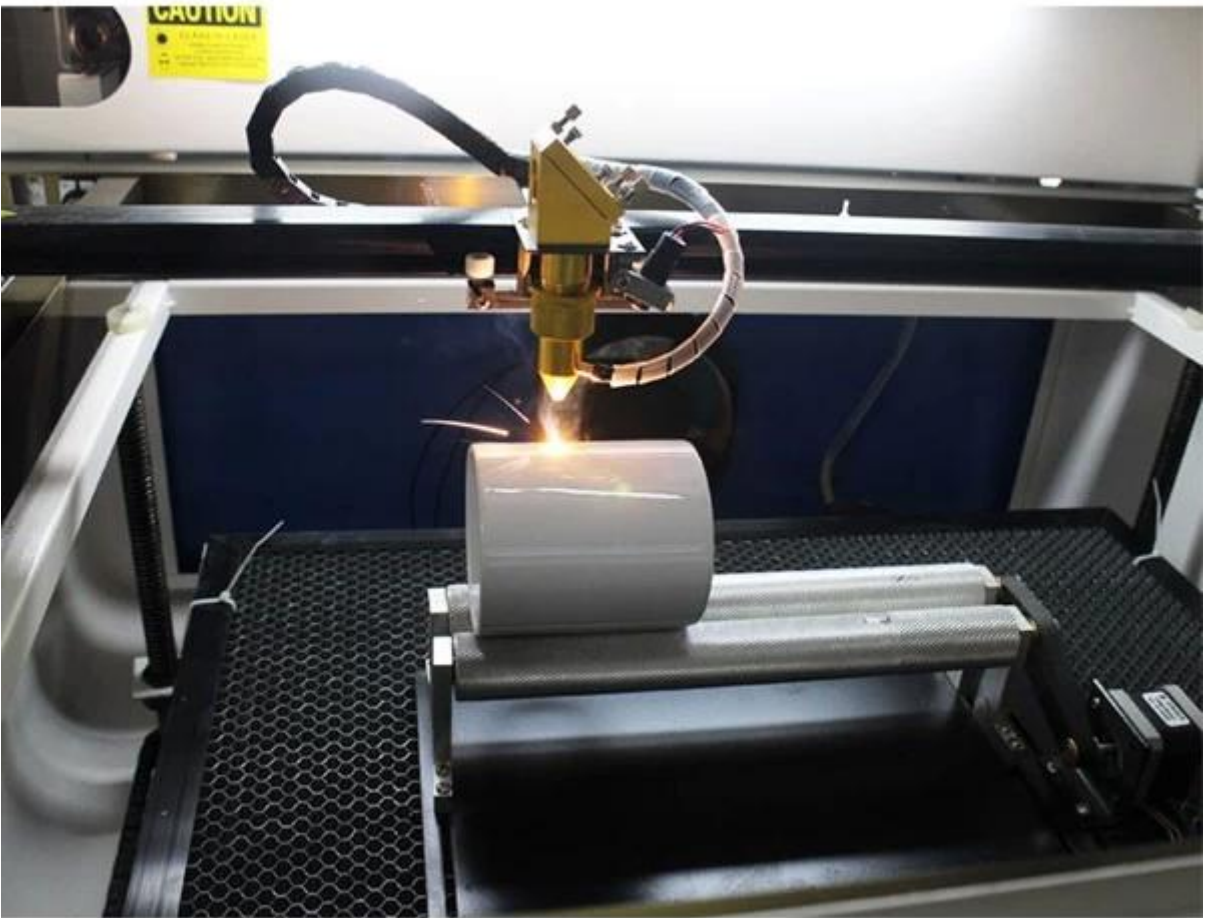
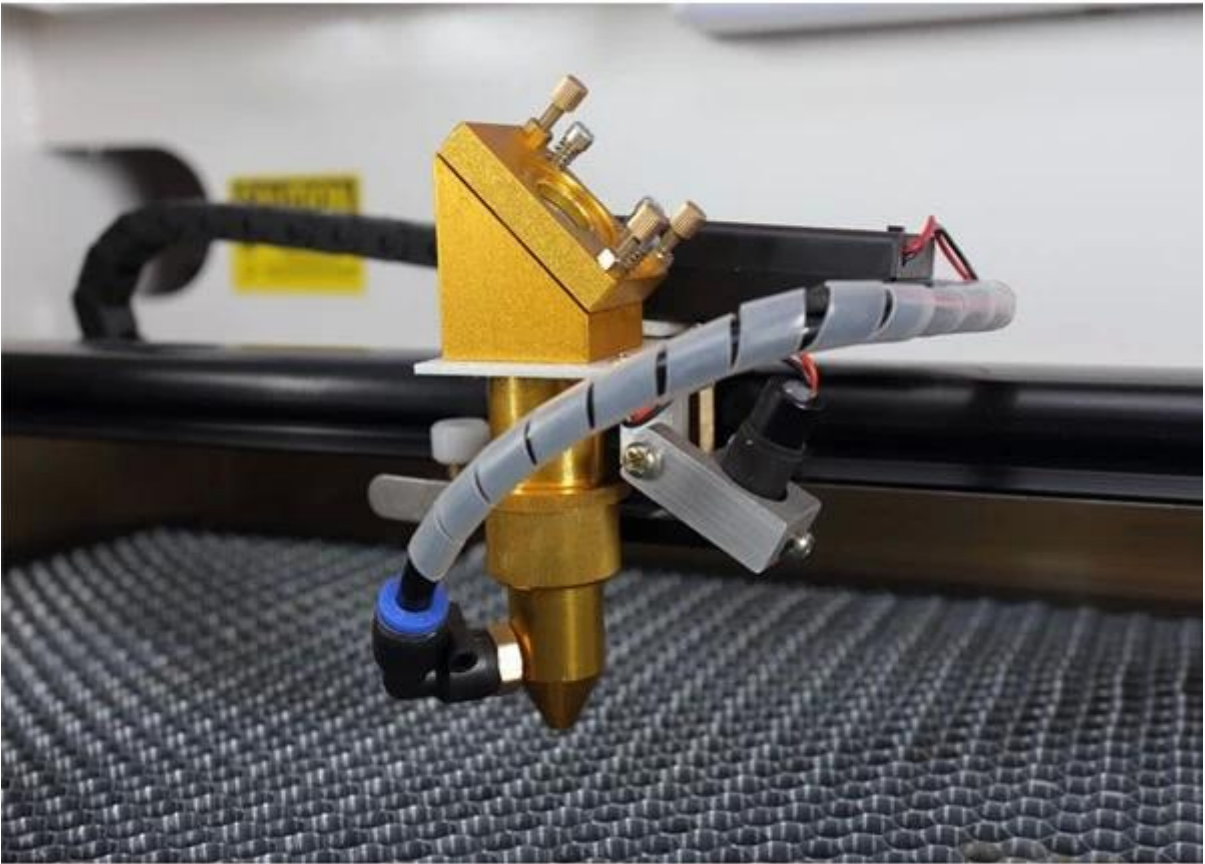

cw-3000 □□ □□ □□

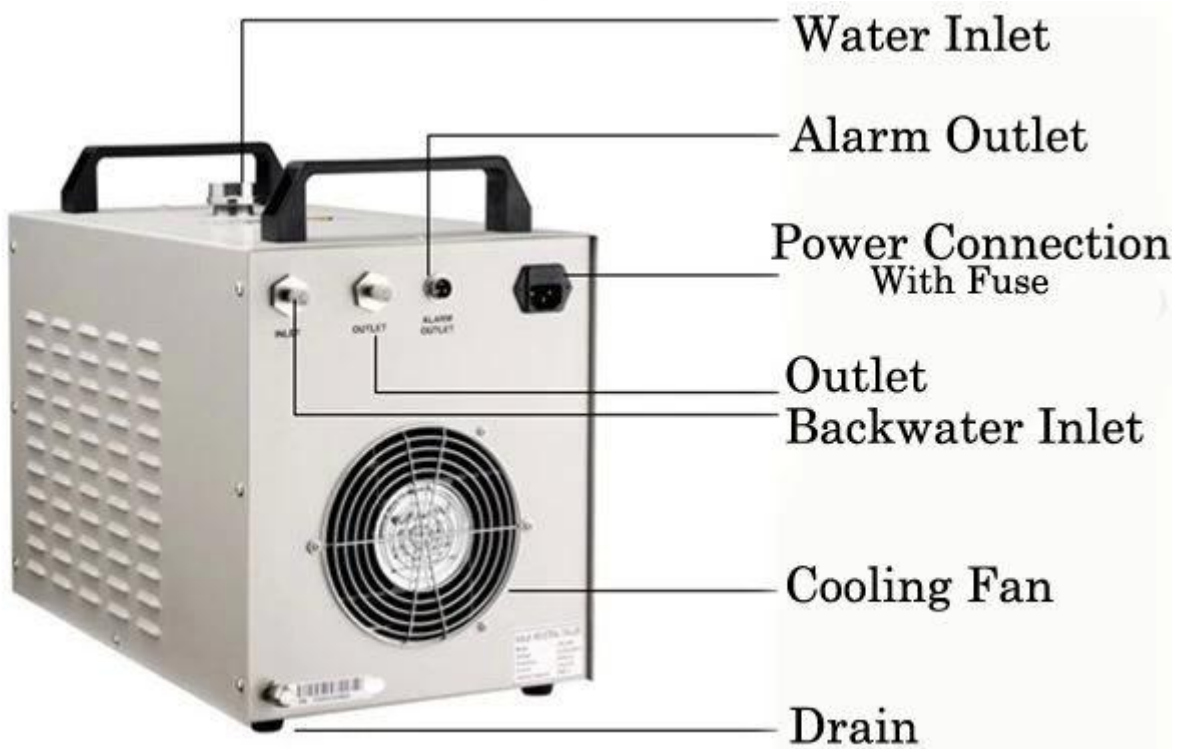

□□ (□□□ □□ □□ □ □□□ □□)

Honeycomb Work Bed Table Platform

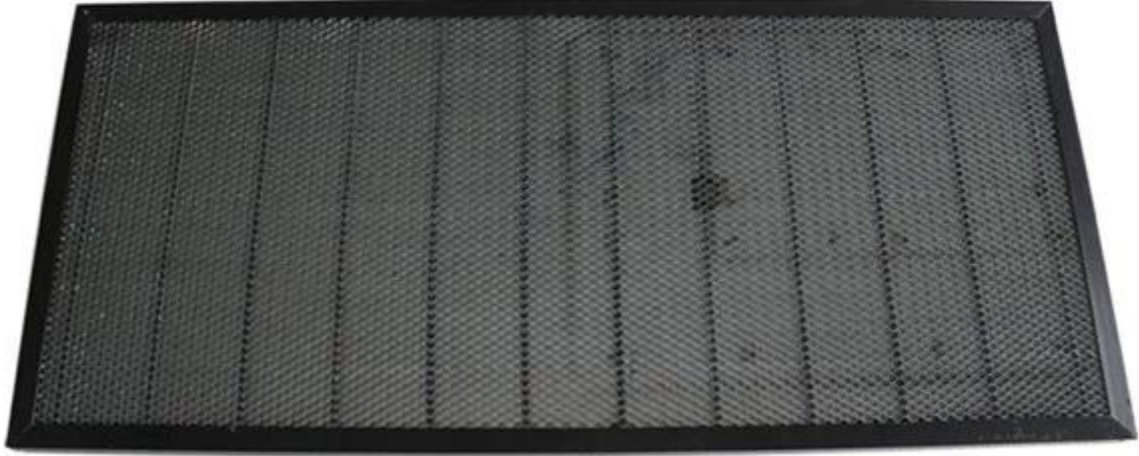

□□ □□ □□ □□ sl-1060 100w dsp □□ □□□□□□ usb □□□□ □□□□ □□ □□ □□



□□ sl-1060 100w dsp □□ co2 usb □□□□ □□□□ □□ □□ □□□□ □ □ □□ □

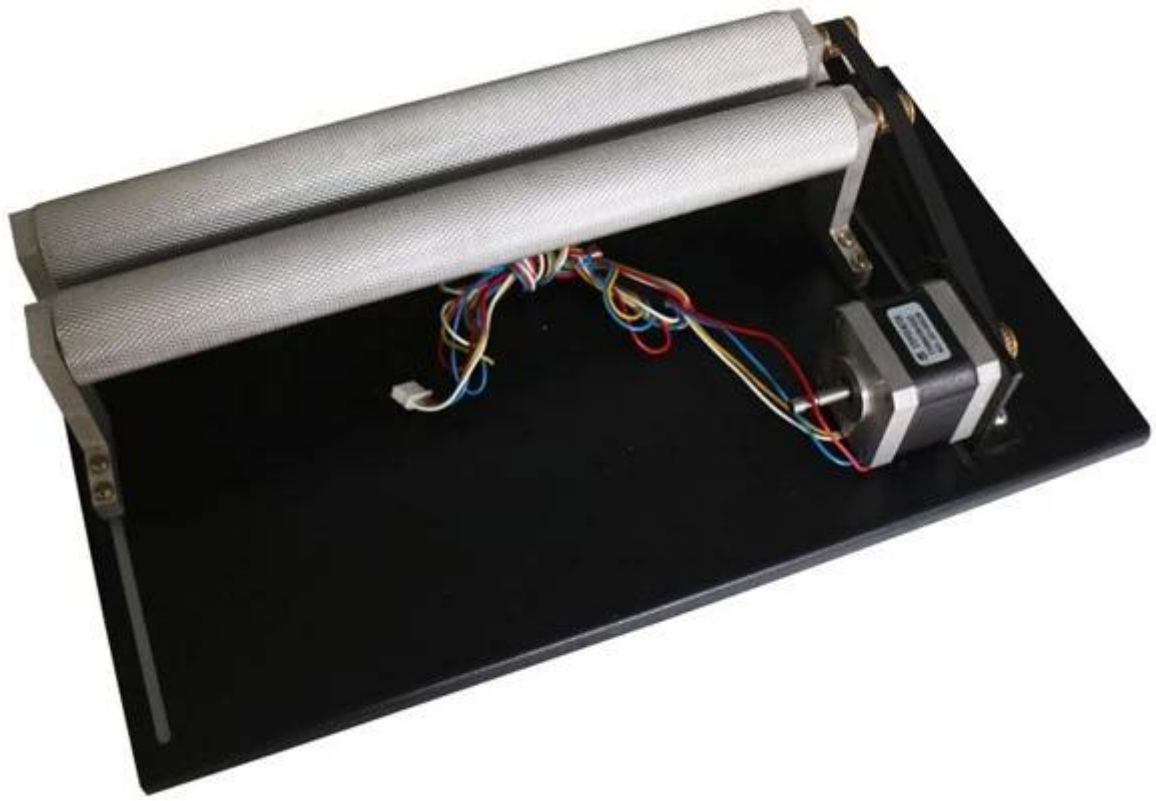

□ sl-1060 100w dsp □□ □□□□□ usb □□□□ □□□□ □□ □□ □□□□ □□□□: □□, □□ □□, □□ □□□□ □□□□, □□ □□, □□□□ □□ □□, □□ □□, □□ □□□□, □□ □□, □□□□ □□, flexo, □□□□ □, □□ □□, □□ □ □□□□, □□ □□, □□□□ □□, □□, □ □ □□□, □□□□□, cabinetry, □□ & □□, □□□□ □ □, □ □□ □, □□ □□□□ □□, □□ & □□□□, □□□□ □□, □ □ □□ & □□□□□, □□ □ □, □□ □□, □□ □□□□□□□□, □□ □, □□ □ □□□, □□ □□□□, □□.

Material	Engrave	Cut
Wood	Yes	Yes
Jade	Yes	
Acrylic	Yes	Yes
Glass	Yes	
Ceramic	Yes	
Delrin	Yes	Yes
Cloth	Yes	Yes
Leather	Yes	Yes
Marble	Yes	
Matte Board	Yes	Yes
Melamine	Yes	Yes
Paper	Yes	Yes
Mylar	Yes	Yes
Press Board	Yes	Yes
Rubber	Yes	Yes
Wood Veneer	Yes	Yes
Fiberglass	Yes	Yes
Painted Metals	Yes	
Tile	Yes	
Plastic	Yes	Yes
Cork	Yes	Yes
Corian	Yes	Yes
Anodized Aluminum	Yes	
Ceramics	Yes	
Stainless Steel	*	
Brass	*	

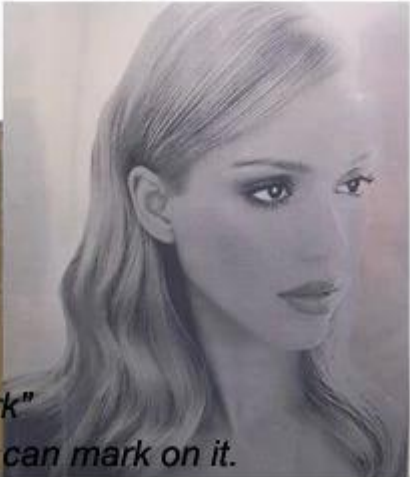

****"means you have to use a spray called "thermark" to spray the surface of the material and then you can mark on it.**



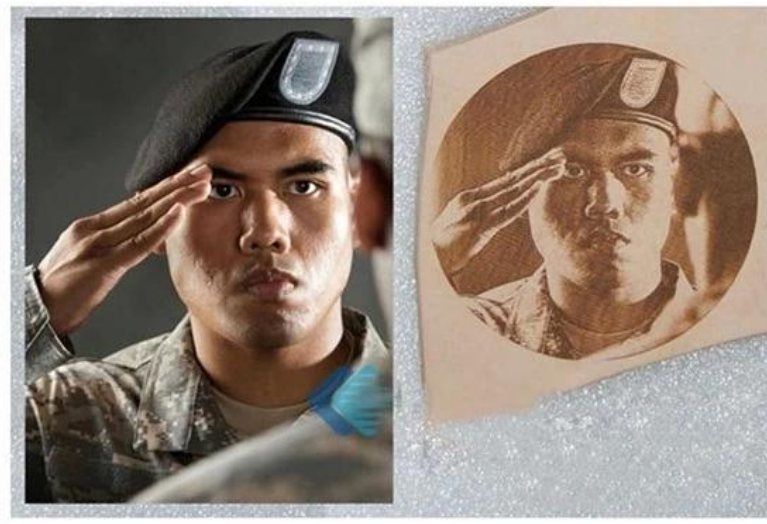
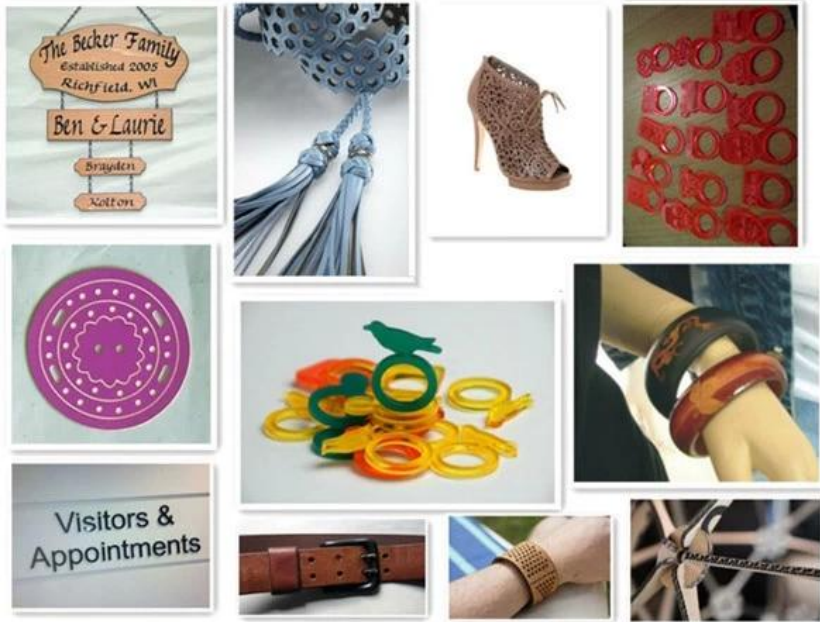

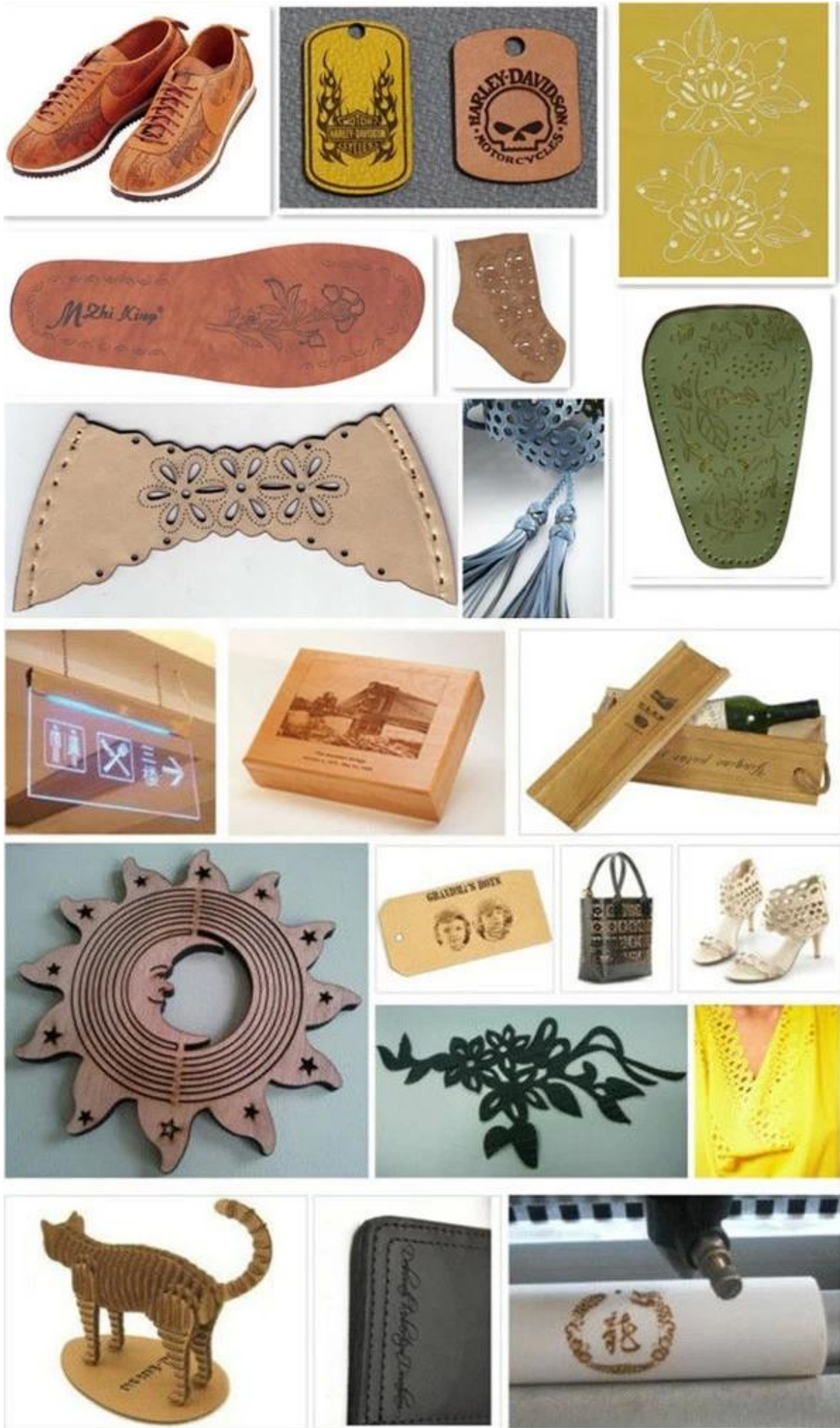

Material	Type	Thickness	Speed
Acrylic	Engrave		
	Cut	15-20MM	2mm/s
Soft wood	Engrave		
	Cut	10MM	6mm/s
Leather	Engrave		
	Cut		30mm/s
Plastic	Engrave		
	Cut		Depending on the material
Glass	Engrave	0.1-0.2MM	
	Cut	Can't	Can't
Plexiglass	Engrave		
	Cut	Effect is not as good as acrylic	Speed slower than the acrylic
PVC	Engrave		
	Cut	Same with acrylic	Same with acrylic
Cloth	Engrave		
	Cut	Usually thin material	50mm/s
Rubber	Engrave		
	Cut	5mm	10mm/s
Bamboo	Engrave		
	Cut	10mm	4mm/s

05 Factory Tour

China  zone





06 **Certifications**

China  zone





□□ □□: □□□ □□ □□□ □□□□:

□□□ □□□ □ □□□□ □□ □□□□ □□ □□□□ **co2** □□□□ □□□?