

ChinaCNCzone 1500w/2200w [cnc 6040](#) 4軸 CNC 產品介紹:

1. 1500w 及 2200W 雙速機

2. 4軸 CNC 機

3. z 軸行程 1050mm, 工作台 1450mm 行程

4. 雙速機

5. 雙速機

6. 雙速機

7. 雙速機

8. 雙速機

9. 雙速機 PCB 板

10. 行程: 80mm

11. 雙速機 [4軸 CNC 機](#) 介紹.

12. [3軸 CNC 機 \(usb cnc 機, usb 機, mach3 機, cnc 機, dsp 機, mach3 機, mach3 機, mach3 usb 機\)](#)

usb 機 介紹?

1. usb 機 cnc 機, usb 機 cnc 機

2. mach3 機

3. 機

Type 1 controller

Front



Back



parallel port +

USB CNC cable (option)



USB Cable

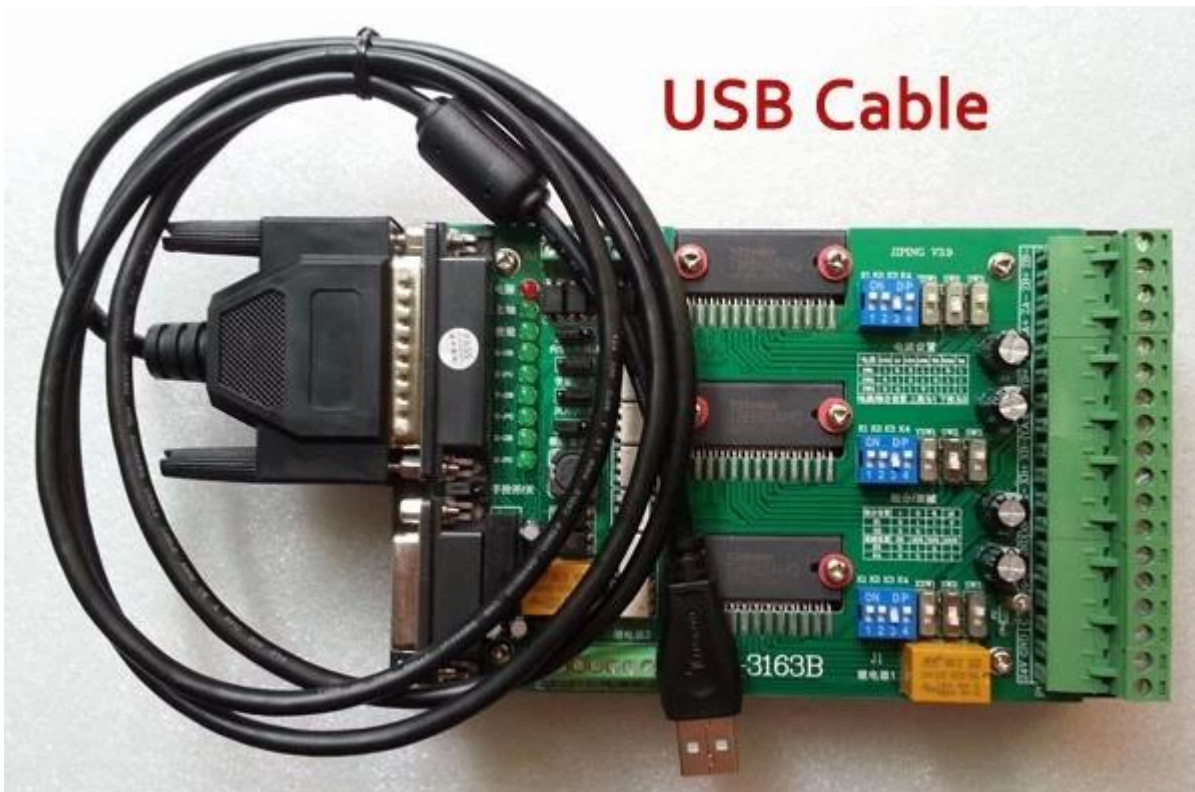

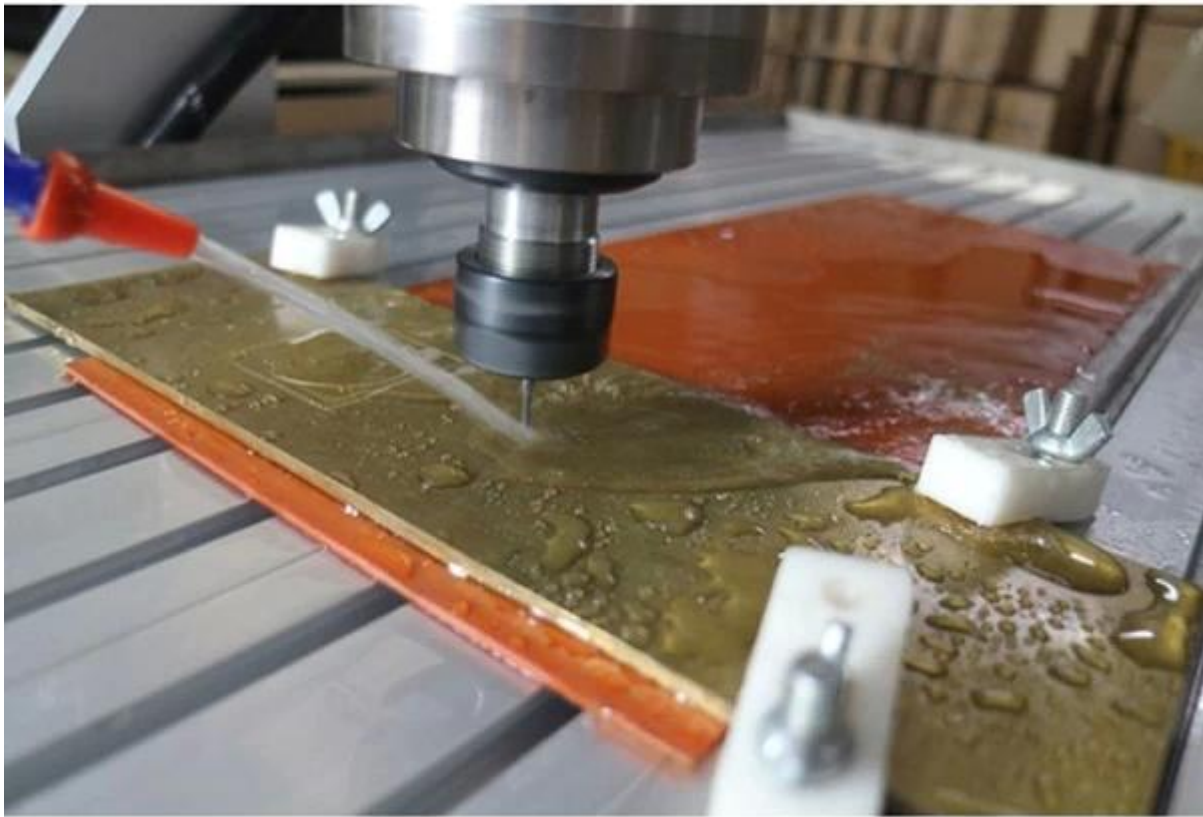

□□□□□□□□□□□□□□□□ [cnc □□□6040 4□?](#)

Model: CNC6040

Shape Dimension

(L)=890mm

(H)=525mm

(W)=690mm

ChinaCNCzone

Effective Working Travel

Workpiece Dimension

Z axis=105mm

145mm

Y axis=600mm

X axis=400mm

z □□□□□ [cnc 6040 4 □?](#)

New Model



Old Model



Z-axis maximum acceptable 65mm

Z-axis maximum acceptable 105mm

□□□ cnc 6040 □□4□□□□□□□□ □□ cnc □□□□?

New Version

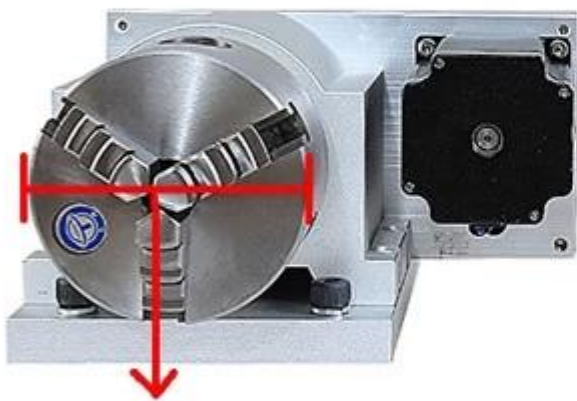

80mm

Old Version

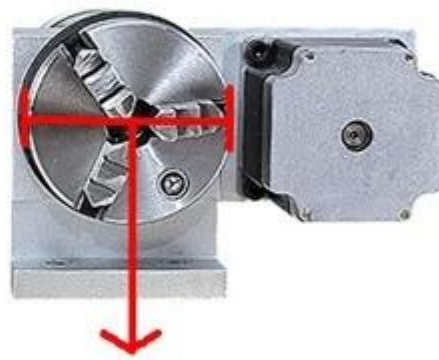

50mm

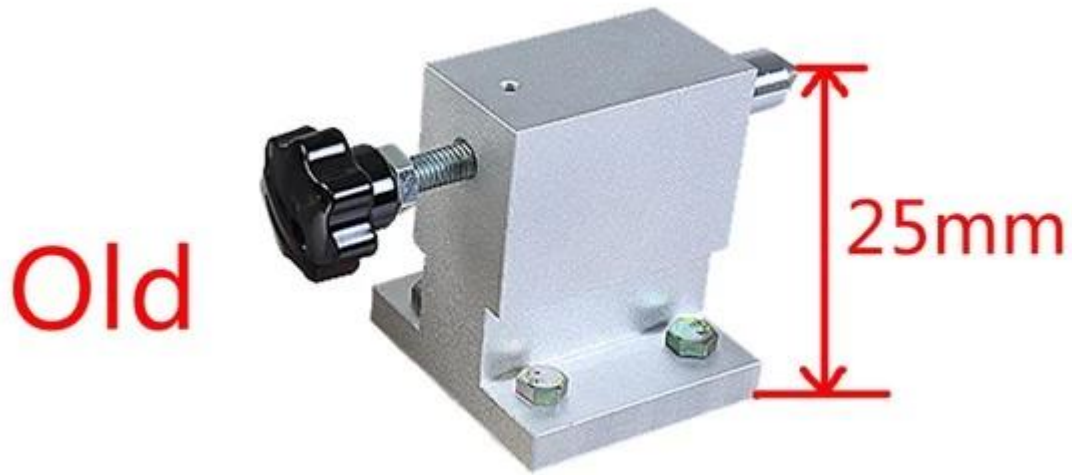

ChinaCNCzone 4 Axis CNC Router 6040 for *Sculpture Round Carving*

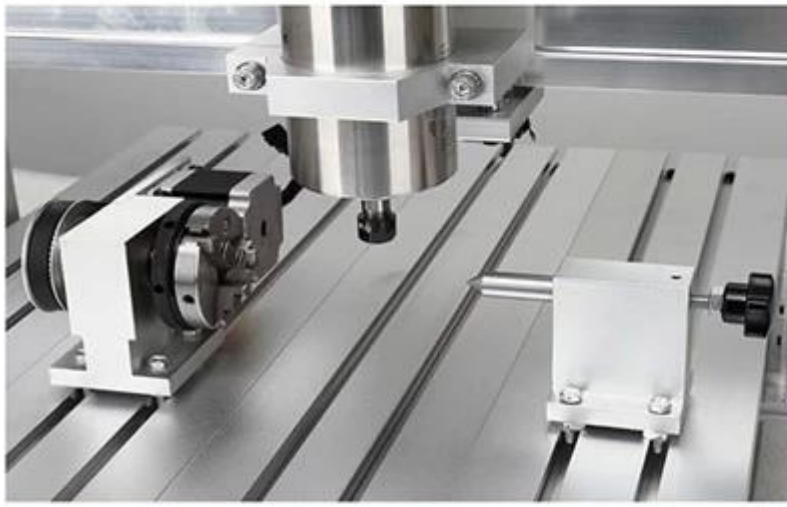

- a: [interested](#)
- b. [ChinaCNCzone 3 usb cnc 6040 3 1500w 2200w](#)
- c. [ChinaCNCzone cnc 6040](#)



Overseas warehouse support (UK, Germany, Australia, USA)
 China warehouse (by sea, air freight & express)

02 Parameters China zone

□□

□□ 1500w/2200W cnc 6040 4 □□□□□□□□		
□□□□□□□□	580 (x) mm * 400 (y) mm * 105 (z) mm	
□□□□	880 * 670 * 640	
□□□□□□	750mm * 450 □□□□□□ < 150mm	
□□□□□□□□□□□□□□	750mm * 480mm	
□□□□□□	□□□□□□□□6063□□□□6061□□□□□□□□ □□□□ □□□□□□□□□□□□□□	
□□□□□□	≤145	
□□□□□□	x □	1605□□□□
	y □	1605□□□□
	z □	1605□□□□
□□□□□□□□□□ □	x □	φ16mm □□□□□□□□□□□□
	y □	φ20mm □□□□□□□□□□□□
	z □	φ13mm □□□□□□□□□□□□
□□□□□□□□□□□□	57 2-□ 3a 150N.cm	

电动机功率	1.5 kw 24000rpm
轴径	er11/3.175 mm/6mm
轴长	0.05 mm
轴孔	0.03 mm
控制方式	g 代码/nc 代码/dxf 文件 nc 代码
接口	usb 接口
操作系统	windows xp/win7 /windows7 /win10
行程	0-4000mm/轴
行程	0-2500mm/轴 (工作台)
控制单元	步进电机 + pwm 驱动器 + TB6560 3 轴控制
接口	usb 接口
控制软件	g 代码
控制单元	mach3/usbnc
电压	24v
电压	ac110v/ac220v
重量 (工作台)	4*85kg
尺寸	尺寸: 122 * 86 * 83





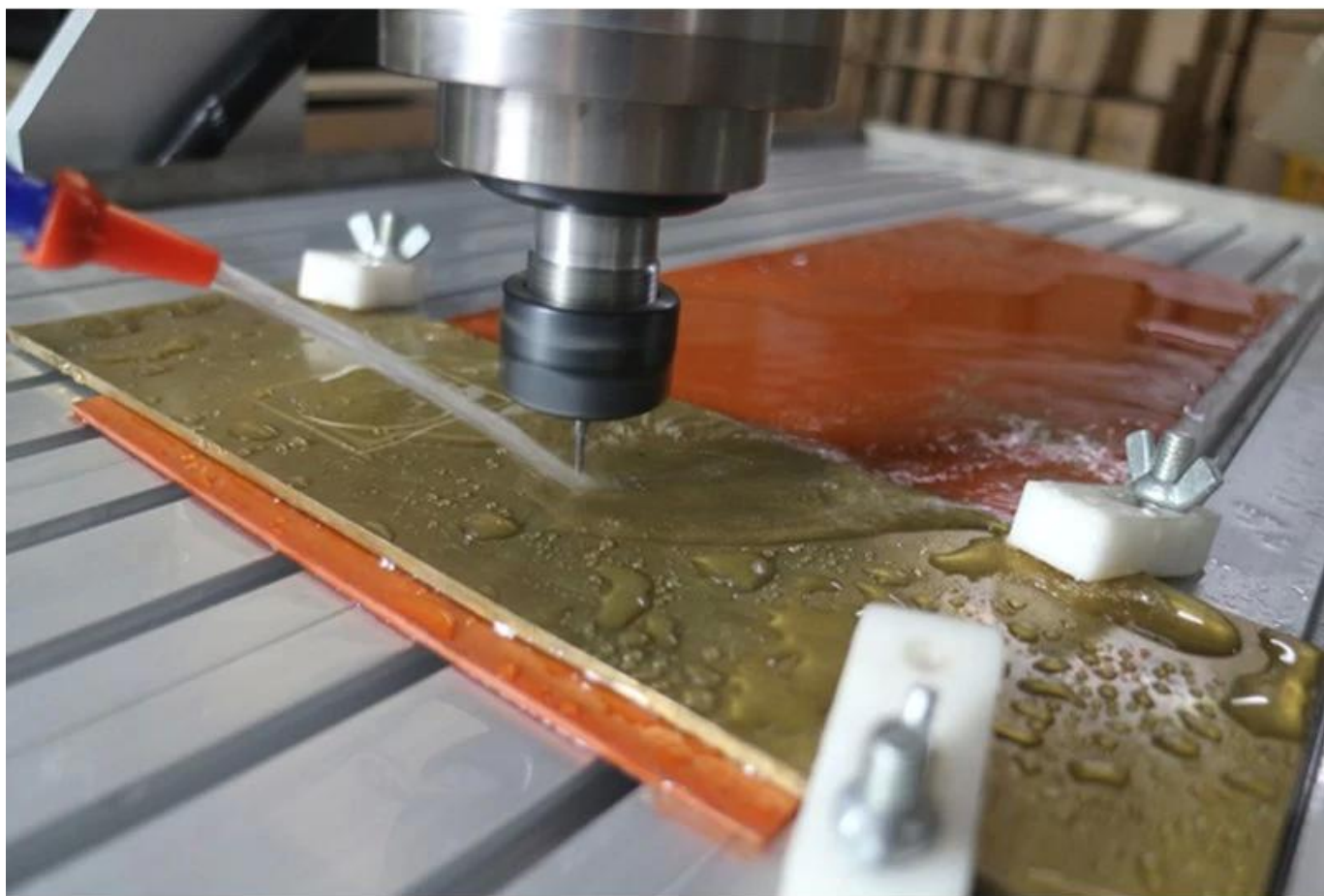





www.chinacnczone.com

Live Demo

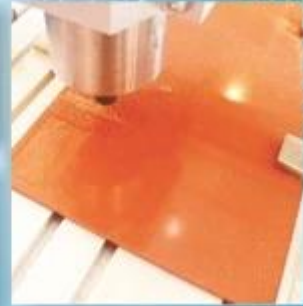

PVC



DOUBLE COLOR BOARDS



WOOD

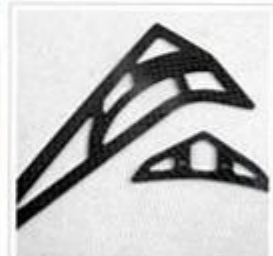

CARBON FIBER REINFORCED
PLASTICS PLATE

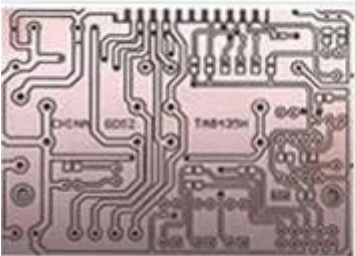

PCB



WAX



DOUBLE COLOR BOARDS



EPOXY TOOLING BOARD







QA Inspection Area



Mechanical Assembly Area



Machine Commissioning Area



Finish Products Area



Packaging Area



Always be imitated, never be surmounted.

We all use well-designed professional aluminum to manufacture the machine. Almost all of the structural member are extruded by a dedicated mold. The production of large quantities so that we have a strong price competitiveness. Professional mold and materials so that our quality has been stable protection.

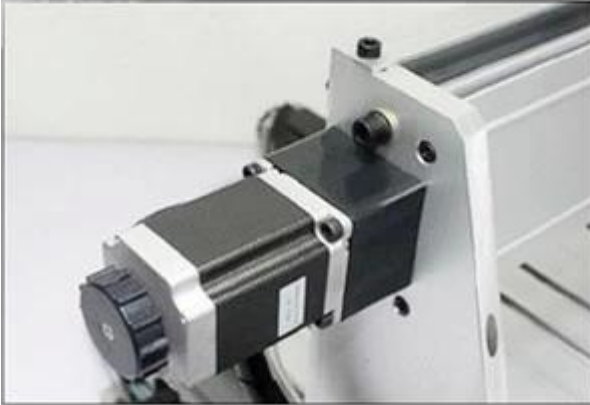



SHENZHEN SCOTLE TECHNOLOGY GROUP LIMITED

ChinaCNCzone, engrave your colorful life!

客户合影及公司文化 Customers and Company Culture

