

**SL-1060 100W DSP-Steuerung [CO2 USB Laser Cutter Laser Cutting Gravur Machine](#) 1000 x 600 mm von chinacnczone**

## **Herausragende Eigenschaften wie unten**

Arbeitsbereich Ares: 600x1000mm

Neue DSP-Controller-Box keine Notwendigkeit, eine Verbindung mit dem Computer.

17HW4410H STEP Motor

Industrieller Ebene Laser Head

Light System: Light System

Blütenfarbe: Bule und weiß

Einstellbare Drehzahl und Leistung

USB-Schnittstelle

Luft-Assist, Entfernen von Hitze und brennbaren Gasen von der Schneide-Oberfläche

Embedded Exhaust Fan, einfachere Installation, sicherer Transport

Rotierende Achse, Gravur jedes zylindrischen Objekt

Mobilfunk-Plattform

Intuitive Control Panel, Set Speed, Power und mehr Kontrollen direkt vom Laser

Wasserkühlung und Schutz-System mit einem kühlen.

Laser-Setzung

Notfall-Stop-Button.

Größere Größe, 600 \* 1000 mm Arbeitsbereich.

Lifting-Plattform ist elektrische Kontrolle, 0-25 cm.

Laser Focal length: 5 cm

Ein Endschalter läßt es nur funktionieren, wenn die Abdeckung geschlossen ist.

Es gibt Chinesisch, Englisch, Russisch, Portugiesisch, Italienisch Sprachen in der Systemsteuerung für Ihre Auswahl

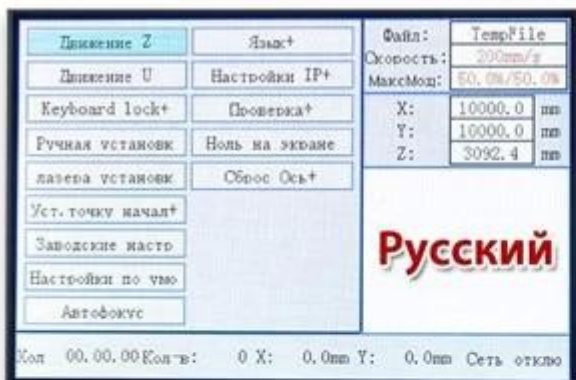
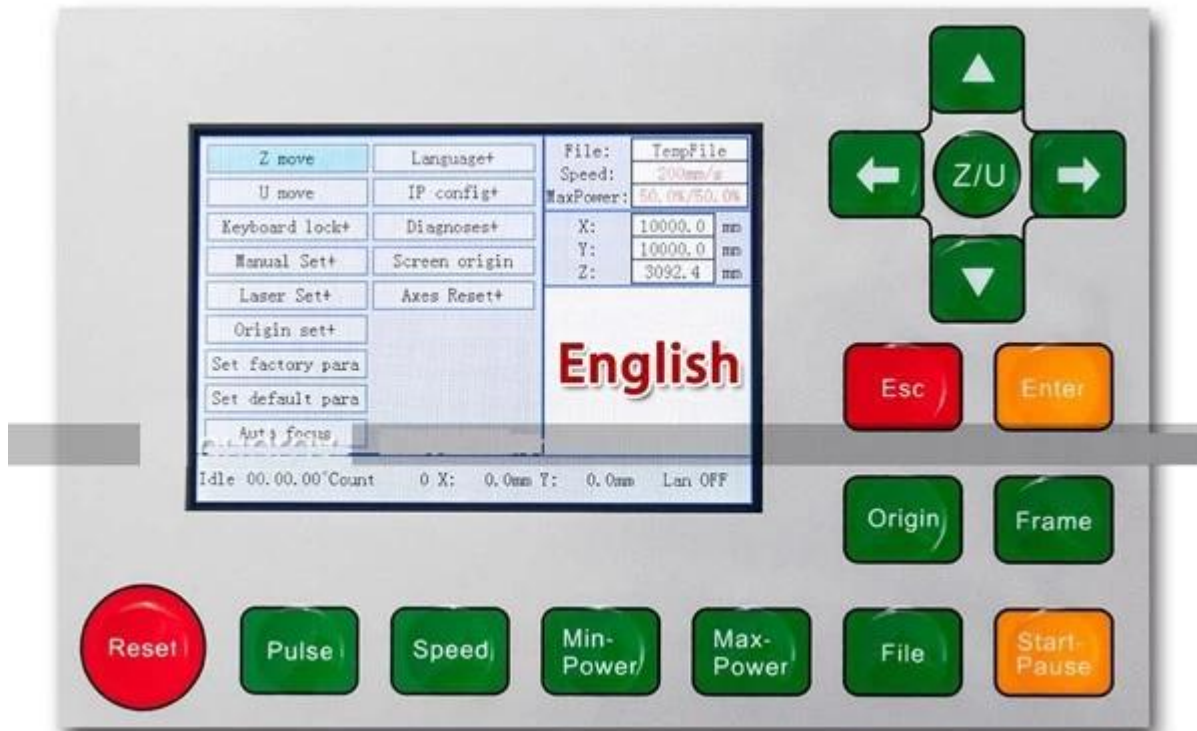

## Packing Liste für dieses SL-1060 100W DSP-Steuerung CO2 USB Laser Cutter Laser Cutting Stich Maschine

- 1 x DSP 1060 100W CO2 Laser Engraving Machine
- 1 x Laser Gravur Software (Down Load Link)
- 1 x Bedienungsanleitung (Down Load Link)
- 1 x CW-3000 Industrial Chiller

1 x Lüfter

1 x Air Pumpe

1 x Verbindungskabel und USB-Kabel

1 x Rotation Achse

1 x-work-Plattform

Zwei Pakete:

1. Maschine Paket: hölzerne Kiste mit Schaum innen

Package Dimension: 154 \* 112 \* 77 cm

Bruttogewicht: 178kg

Gewicht des Pakets: 267kg

2. Chiller Paket: cartonbox mit Schaum Inside

Package Dimension: 57 \* 48 \* 35 cm

Bruttogewicht: 12 kg

Gewicht des Pakets: 20 kg



Parameter für diesen DSP 1060 [CO2 Laser Cutter](#)

Totale Leistung	< 300 w
Laser-Leistung	100W
Laser-Typ	<a href="#">CO2 Laser Gravur Maschine</a>
Stromversorgung	AC 220V/110 v
Arbeitsbereich	600 * 1000 mm
Gravur Tiefe	0-20 mm (unterschiedliches Material unterscheidet sich)
Tiefe schneiden	0-20 mm
Gravur Geschwindigkeit	0-800 mm/s
Geschwindigkeit schneiden	0-800 mm/s
Lifting-Plattform	0-250 mm workTable
Auffinden von Präzision	< 0,01 mm
Min Shaping Character	Character: 2 * 2 mm, Letter: 1 * mm

Betriebstemperatur	5 ° c-45 ° c
Luftfeuchtigkeit	5%-95%
Auflösung Ratio	≤ 1000 dpi
Datenübertragung Schnittstelle	USB 2,0 (offline)
Systemumgebung	Windows XP/Win 7/Win 8
Kühlung	Wasserkühlung und Schutz-System mit Chiller
Unterstütztes grafisches Format	Die Dateien, die CorelDRAW & WinsealXP identifizieren können (BMP, JPEG, PLT, CDR, Ai,) TIFF, PCX, DIB, TIF
Kompatible Software	CorelDRAW, winsealxp
Color Separation	Nein
Schräge Gravur	Nein
Schutz	Emergency Stop Buttom und aufhören zu arbeiten, wenn Wasser gebrochen
Abmessungen der Maschine	140 * 75 * 58 cm
Verpackung	Hölzerne Kiste mit Schaum innen
Package-Dimension	157 * 94 * 78 cm
Gewicht Package	230 kg (gerechnet ab dem Gewicht des Volumens)















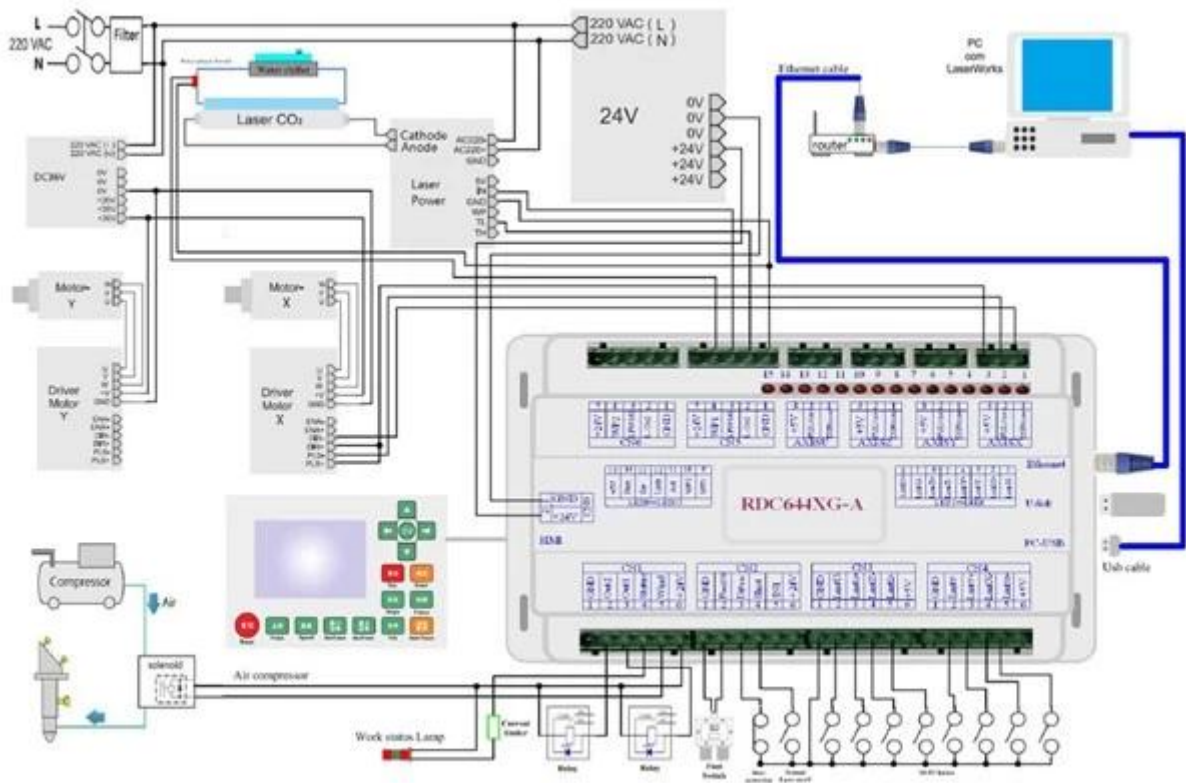
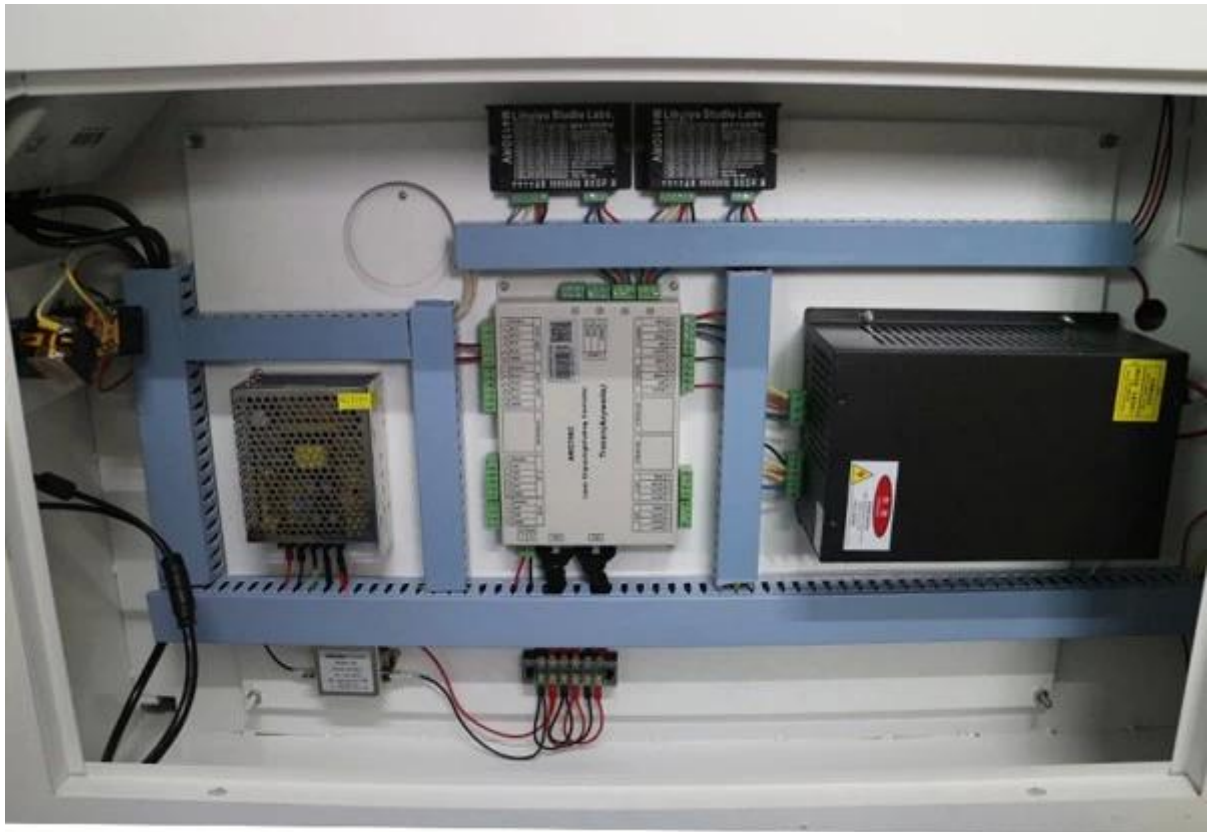

Red dot Positionierung Funktion (Umriss oder Laser-Punkt-Position)

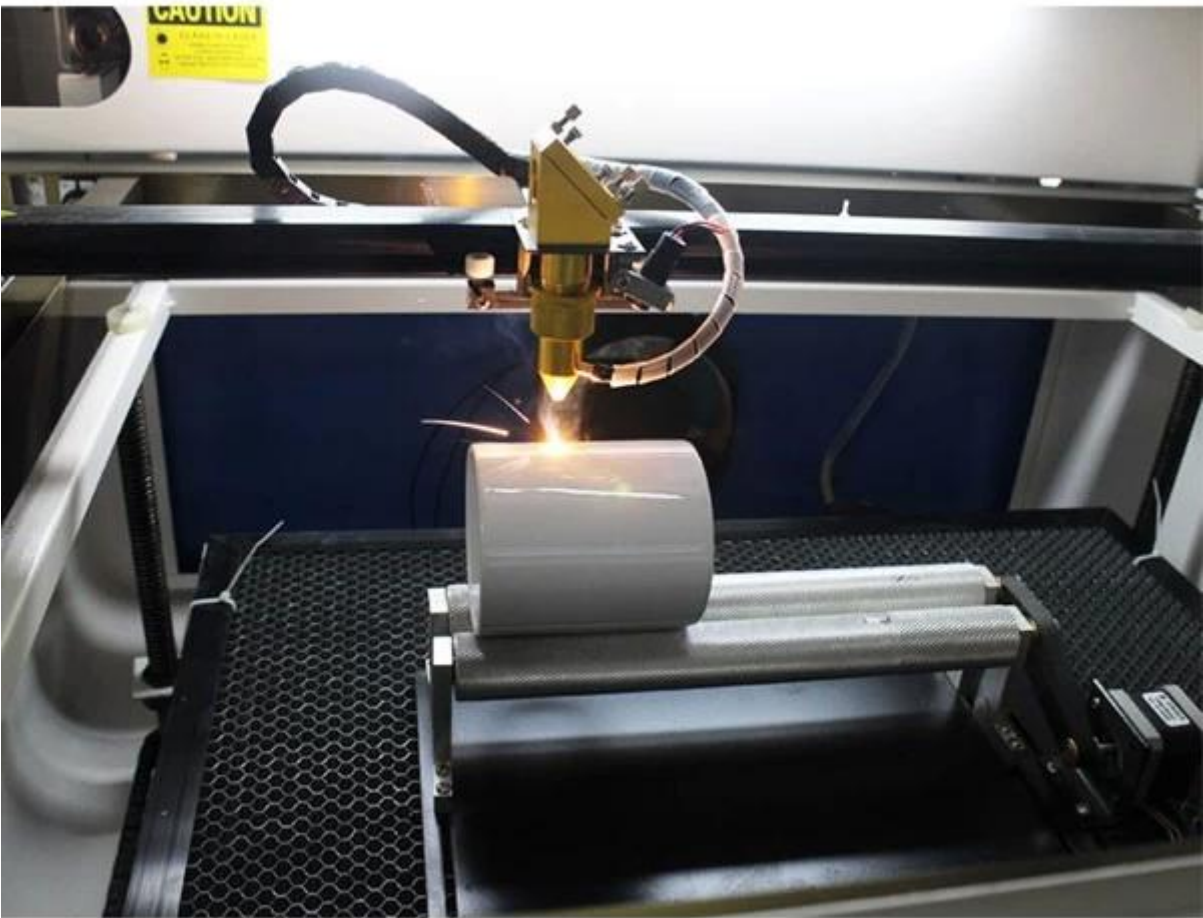
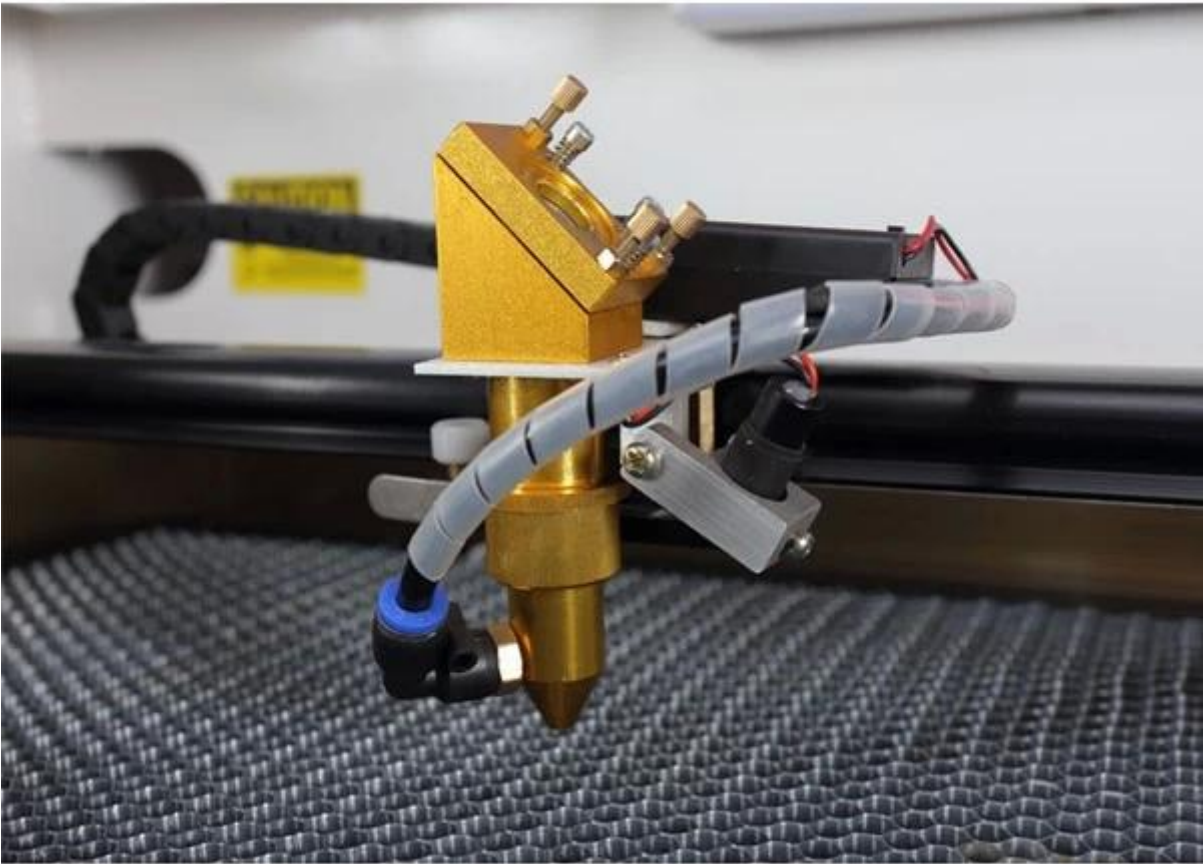

Der CW-3000 Industrial Chiller

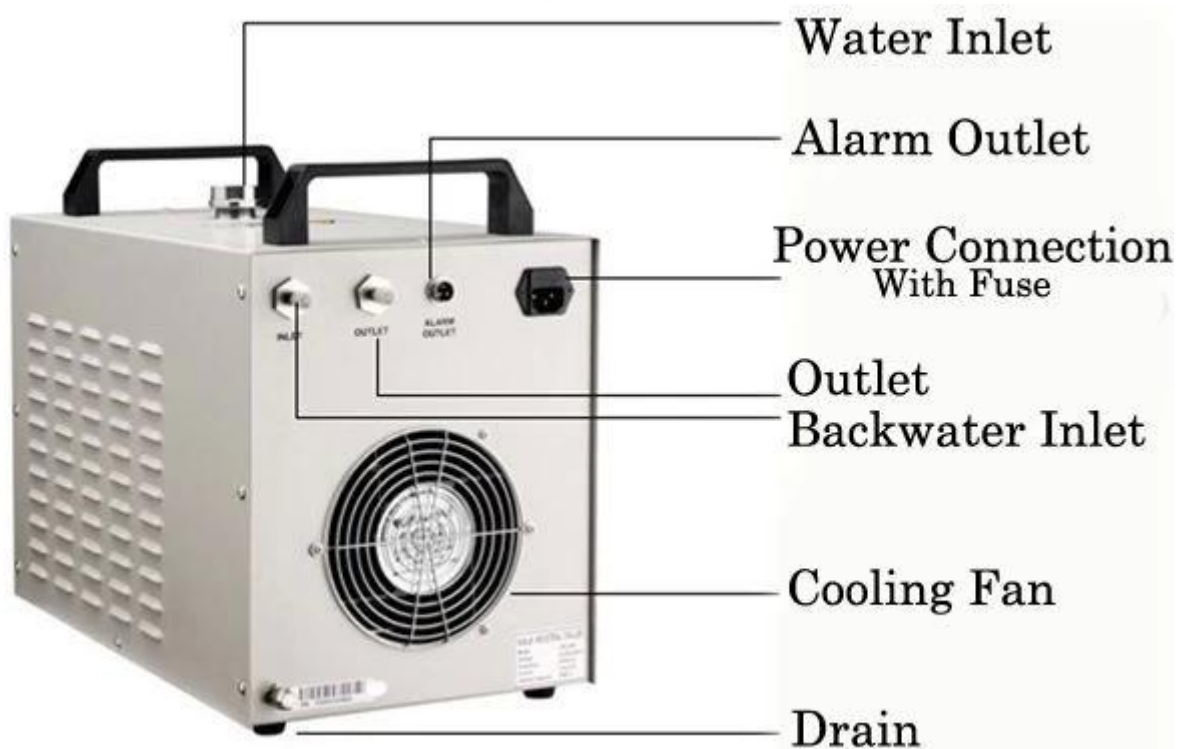



Honig (für weiche Materialien, Gravur und schneiden)

## Honeycomb Work Bed Table Platform

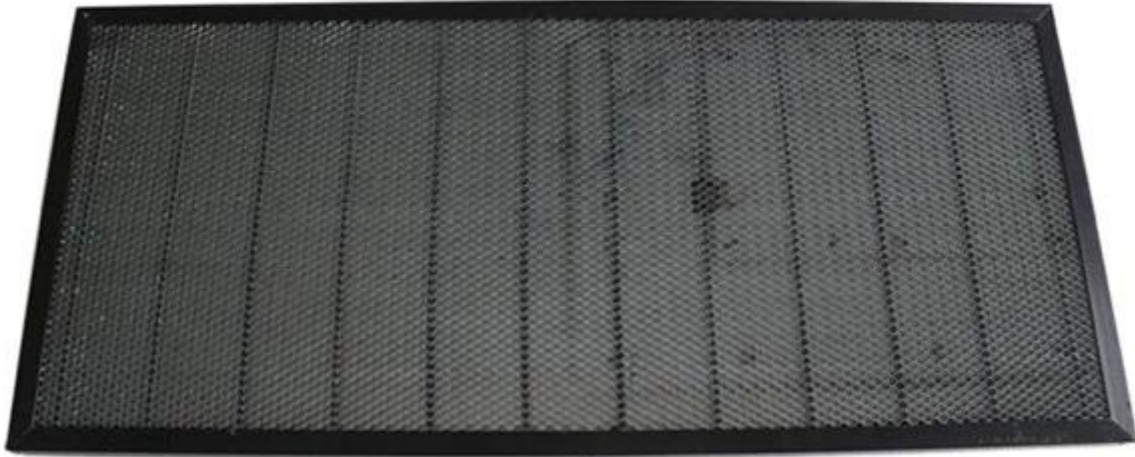

Air Pump für dieses SL-1060 100W DSP Steuerung CO2 USB Laser Cutter Laser Cutting Stich Maschine



Rotator Achse für dieses SL-1060 100W DSP Steuerung CO2 USB Laser Cutter Laser Cutting Gravur Maschine

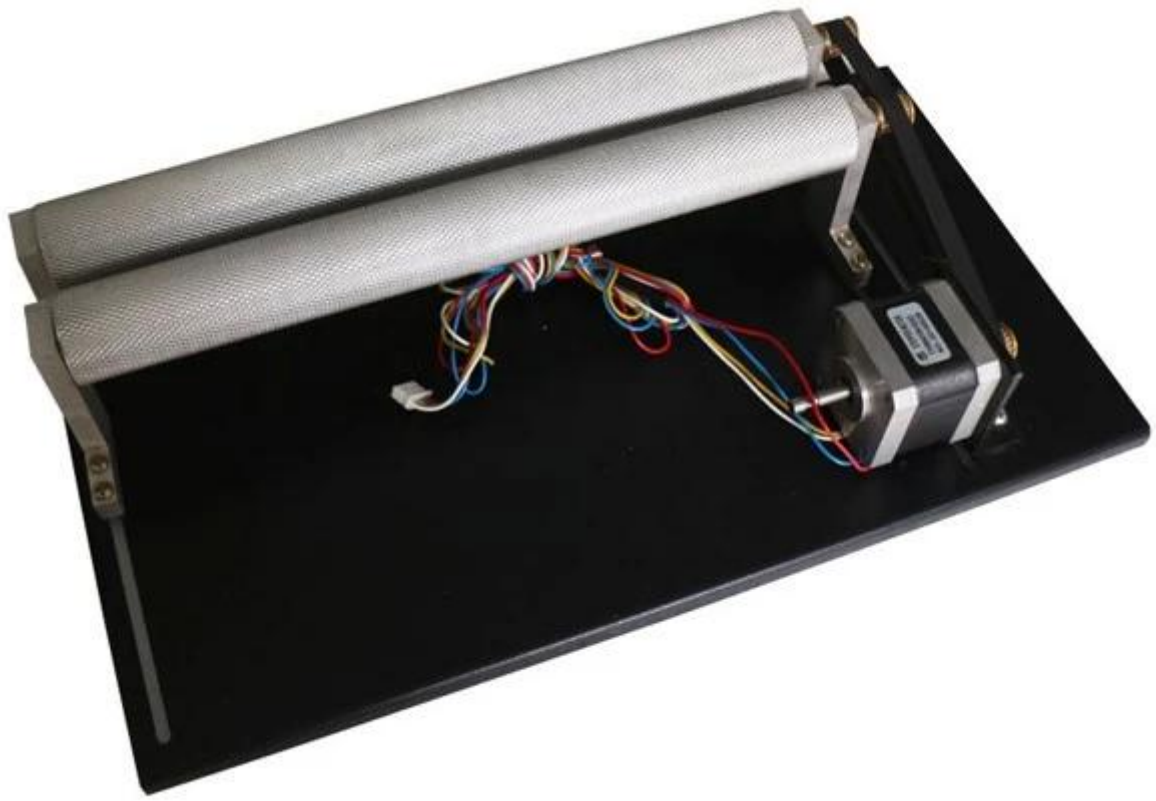

Dieses SL-1060 100W DSP Steuerung CO2 USB Laser Cutter Laser Cutting Stich Maschine eignet sich für: Holzverarbeitung, Textile schneiden, Industrial Prototyping, industrielle Kennzeichnung, Signmaking, Medical Part Kennzeichnung, Luft-und Raumfahrt, architektonische Modellierung, Spezial-Werbung, Kunststoffe Herstellung, bestellen, Punkt des Kaufs, Stempel, Bild Framing, Gift Manufacturing, Barcode, Gravur, Dichtung schneiden, Rätsel, Schränke, Auszeichnungen & Anerkennung, personalisierte Stifte, Tür Pulls, Schnitt Scroll Patterns, Spiele & Spielzeug, Finger Gelenke, Einlagen & Overlays, Brüderlichkeit Paddel, Musik-Boxen, Licht-Schalter-Platten, Schmuck-Boxen, Teile-Kennzeichnung, Router-Templates, Schreibtisch.

Material	Engrave	Cut
Wood	Yes	Yes
Jade	Yes	
Acrylic	Yes	Yes
Glass	Yes	
Ceramic	Yes	
Delrin	Yes	Yes
Cloth	Yes	Yes
Leather	Yes	Yes
Marble	Yes	
Matte Board	Yes	Yes
Melamine	Yes	Yes
Paper	Yes	Yes
Mylar	Yes	Yes
Press Board	Yes	Yes
Rubber	Yes	Yes
Wood Veneer	Yes	Yes
Fiberglass	Yes	Yes
Painted Metals	Yes	
Tile	Yes	
Plastic	Yes	Yes
Cork	Yes	Yes
Corian	Yes	Yes
Anodized Aluminum	Yes	
Ceramics	Yes	
Stainless Steel	*	
Brass	*	



**"" means you have to use a spray called "thermark" to spray the surface of the material and then you can mark on it.**





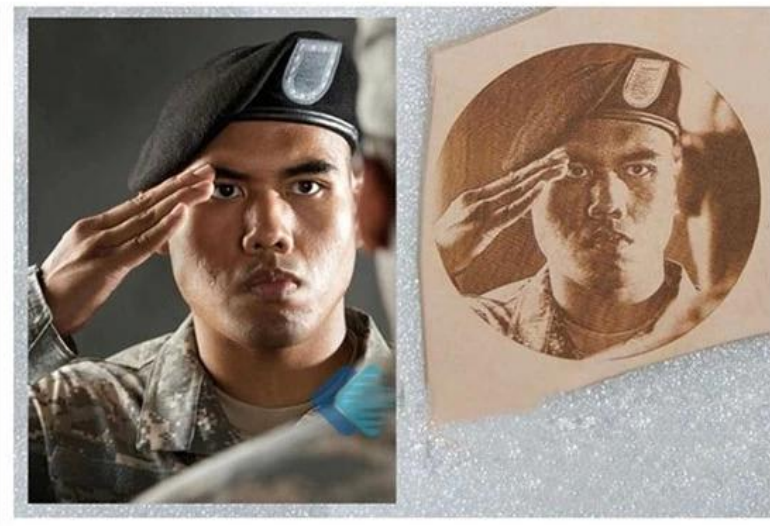



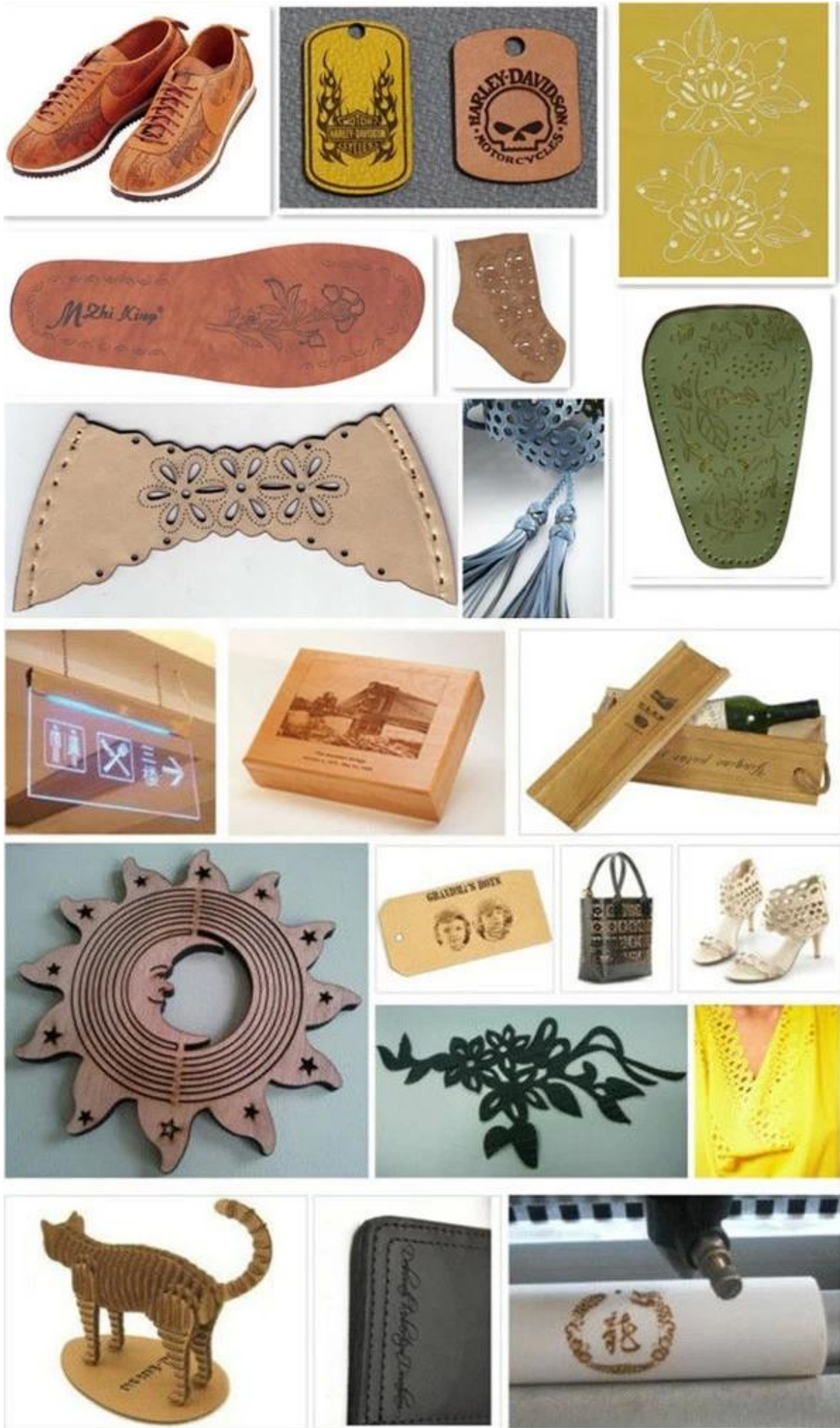

Material	Type	Thickness	Speed
Acrylic	Engrave		
	Cut	15-20MM	2mm/s
Soft wood	Engrave		
	Cut	10MM	6mm/s
Leather	Engrave		
	Cut		30mm/s
Plastic	Engrave		
	Cut		Depending on the material
Glass	Engrave	0.1-0.2MM	
	Cut	Can't	Can't
Plexiglass	Engrave		
	Cut	Effect is not as good as acrylic	Speed slower than the acrylic
PVC	Engrave		
	Cut	Same with acrylic	Same with acrylic
Cloth	Engrave		
	Cut	Usually thin material	50mm/s
Rubber	Engrave		
	Cut	5mm	10mm/s
Bamboo	Engrave		
	Cut	10mm	4mm/s

## 05 Factory Tour

China  zone







06 **Certifications**

**China  zone**







Freundlicher Hinweis: Sie können sich für den folgenden Artikel interessieren:  
[Wie man die Wasser-Chiller & Air Pumpe zu ChinaCNCzone Desktop CO2 Laser Gravur Maschine?](#)